

# Practical Guidelines for the Fabrication of Austenitic Stainless Steels

# Practical Guidelines for the Fabrication of Austenitic Stainless Steels

Second edition 2020

© IMOA 2010–2020

ISBN 978-1-907470-13-4

Published by the International Molybdenum Association (IMOA), London, UK  
www.imoa.info

Co-published by the International Chromium Development Association (ICDA), Paris, France,  
www.icdacr.com  
and the Nickel Institute, Toronto, Canada,  
www.nickelinstitute.org

Prepared by TMR Stainless, Pittsburgh, PA, USA,  
the Nickel Institute and IMOA.

Second edition edited by Dr. James Fritz, Pittsburgh, PA, USA.  
First edition edited by Curt Kovach, Pittsburgh, PA and Dr. John Shields, Cleveland, OH, USA.

Designed by circa drei, Munich, Germany

Acknowledgement:

IMOA is grateful to Outokumpu for providing technical data.

The International Molybdenum Association (IMOA) has made every effort to ensure that the information presented is technically correct. However, IMOA does not represent or warrant the accuracy of the information contained in this handbook or its suitability for any general or specific use. The reader is advised that the material contained herein is for information purposes only; it is not intended as a substitute for any person's procedures, and should not be used or relied upon for any specific or general application without first obtaining competent advice. IMOA, its members, staff and consultants specifically disclaim any and all liability or responsibility of any kind for loss, damage, or injury resulting from the use of the information contained in this publication. ASTM's and EN international specifications were used predominantly in this publication; however, material specifications may vary among countries.

Cover photo: Welding the inside of a stainless steel heat exchanger.  
© iStock.com/MEDITERRANEAN

## Table of Contents

<b>1</b>	<b>Introduction</b>	<b>4</b>
<b>2</b>	<b>History of austenitic stainless steels</b>	<b>5</b>
<b>3</b>	<b>Metallurgy</b>	<b>8</b>
3.1	Types of stainless steels	8
3.1.1	Austenitic stainless steel	8
3.1.2	Ferritic stainless steel	9
3.1.3	Duplex stainless steel	9
3.1.4	Martensitic stainless steel	9
3.1.5	Precipitation hardening stainless steel	10
3.2	Phase Constituents	10
3.3	Detrimental secondary phases	11
3.3.1	Temperature of secondary phase stability	11
3.3.2	Kinetics of secondary phase formation	11
<b>4</b>	<b>Role of alloying elements</b>	<b>15</b>
4.1	Chromium (Cr)	15
4.2	Nickel (Ni)	15
4.3	Molybdenum (Mo)	15
4.4	Carbon (C)	15
4.5	Nitrogen (N)	15
4.6	Manganese (Mn)	15
4.7	Copper (Cu)	16
4.8	Silicon (Si)	16
4.9	Niobium/columbium (Nb/Cb) and titanium (Ti)	16
4.10	Sulfur (S) and phosphorus (P)	16
<b>5</b>	<b>Mechanical and physical properties</b>	<b>17</b>
5.1	Strength	17
5.2	Ductility and toughness	17
5.3	High-temperature strength	19
5.4	Physical properties	20
<b>6</b>	<b>Corrosion resistance</b>	<b>24</b>
6.1	General corrosion	24
6.2.	Localized corrosion	24
6.2.1	Pitting and crevice corrosion	24
6.2.2	Effect of secondary phases on localized corrosion	26
6.2.3	Stress corrosion cracking	26
6.3	Intergranular corrosion/sensitization corrosion	28
6.3.1	Weld sensitization/weld decay	28
6.3.2	Knife-line attack	29
6.4	Galvanic corrosion	29
6.5	Relations between fabrication and corrosion resistance	31
<b>7</b>	<b>Care in the shop – keeping the surface smooth and clean</b>	<b>32</b>
7.1	Initial delivery and storage	32
7.2	Strippable protective films	33
7.3	Avoiding iron contamination	34

<b>8</b>	<b>Hot and cold forming</b>	<b>35</b>	<b>13</b>	<b>Mechanical joining methods</b>	<b>68</b>
8.1	Hot forming	35	13.1	Joining methods	68
8.2	Warm forming	36	13.1.1	Bolting and screwing	68
8.3	Cold forming	36	13.1.2	Riveting	68
8.3.1	Bending	37	13.1.3	Clinching	68
8.3.2	Roll forming	38	13.1.4	Lock seaming	69
8.3.3	Drawing and stretching	39	13.1.5	Adhesive bonding	70
8.3.4	Spin forming	40	13.2	Corrosion considerations with mechanical joints	70
8.3.5	Cold heading	40	13.2.1	Crevice corrosion	70
			13.2.2	Galvanic corrosion	71
<b>9</b>	<b>Cutting</b>	<b>41</b>	<b>14</b>	<b>Surface finishes</b>	<b>72</b>
9.1	Saw cutting	41	14.1	Finish and performance	72
9.1.1	Power hacksawing	41	14.2	Steel mill supplied finishes	73
9.1.2	Band sawing	41	14.2.1	Plate	73
9.2	Abrasive disc cutting	41	14.2.2	Sheet and strip	74
9.3	Shearing	42	14.3	Mechanically applied finishes	74
9.3.1	Equipment requirements	42	14.3.1	Specialized mechanical finishes	76
9.3.2	Sheared edges	42	14.3.2	Buffing	77
9.3.3	Blanking and piercing	43	14.3.3	Abrasives for mechanical finishing	77
9.4	Water jet cutting	44	14.4	Coined and embossed finishes	78
9.5	Plasma cutting	44	14.5	Colored stainless steel	78
9.6	Laser cutting	45	14.6	Electropolishing	80
			14.7	Restoring and protecting the finish after fabrication	80
<b>10</b>	<b>Machining</b>	<b>46</b>	<b>15</b>	<b>Post-fabrication cleanup</b>	<b>81</b>
10.1	General guidelines	46	15.1	Common forms of damage and surface contamination	81
10.2	Machinability index for different stainless steel grades	47	15.1.1	Iron contamination	81
10.3	Turning	48	15.1.2	Organic compound contamination	81
10.4	Face milling with cemented carbides	48	15.1.3	Oxide scale formed during annealing and welding	82
10.5	Twist drilling with high-speed steel drills	50	15.1.4	Other defects	82
			15.2	Post-fabrication cleanup methods	83
<b>11</b>	<b>Heat treatment – annealing and stress relieving</b>	<b>51</b>	15.2.1	Sandblasting	83
11.1	Solution annealing	51	15.2.2	Glass bead blasting	83
11.1.1	Preparation	51	15.2.3	Grinding and polishing	83
11.1.2	Temperature	52	15.2.4	Stainless steel wire brush/ stainless steel wool	84
11.1.3	Annealing time	52	15.2.5	Degreasing	84
11.1.4	Atmospheres	53	15.2.6	Acid pickling	84
11.1.5	Cooling	53	15.2.7	Passivation	85
11.1.6	Post anneal cleanup	53	15.2.8	Electropolishing	85
11.2	Stress relieving	53	15.3	Influence of cleaning method on corrosion resistance	86
<b>12</b>	<b>Welding, brazing and soldering</b>	<b>55</b>		<b>References</b>	<b>87</b>
12.1	Welding	55		<b>Suggested additional reading</b>	<b>89</b>
12.1.1	Physical property effects on welding	55		<b>ASTM specifications</b>	<b>90</b>
12.1.2	Weld edge and fit-up	56		<b>EN specifications</b>	<b>92</b>
12.1.3	Filler metals	57		<b>Registered trademarks and trade names</b>	<b>93</b>
12.1.4	Shielding	57			
12.1.5	Welding processes	58			
12.1.6	Dissimilar metal welding (DMW)	63			
12.1.7	Weldment quality considerations	63			
12.2	Brazing and soldering	66			
12.2.1	Brazing	66			
12.2.2	Soldering	67			

# 1 Introduction

A wide range of austenitic stainless steel grades are available for use in applications from indoor decorative components such as wall panels and railings to piping and vessels for the corrosive environments found in chemical processing and power

industries. The standard austenitic grades such as Types 304 and 316 dominate the market place by volume. However, more highly alloyed grades have demonstrated cost-effective performance in a variety of demanding applications. These materials are called

“High Performance Austenitic Stainless Steels” (HPASS). They obtain their performance through alloying with higher amounts of chromium (Cr), molybdenum (Mo), nickel (Ni) and nitrogen (N), compared to standard grades. The higher alloying content of HPASS makes processing and fabricating more complex than for standard stainless steels, and demand that engineers, designers, and fabricators have thorough knowledge of their characteristics in order to specify and fabricate them successfully. This brochure provides basic information on HPASS grades and compares them to standard grades. Its primary focus is to compare the fabrication characteristics of the two groups of steels, and to identify similarities and differences between them. This information will help those responsible for fabricating standard and high performance austenitic stainless steels to manufacture a high-quality product that will perform successfully in the field.



HPASS in a flue gas scrubber application. © Outokumpu

## 2 History of austenitic stainless steels

Stainless steels were introduced at the beginning of the twentieth century as a result of pioneering work in England and Germany. In the ensuing half century, manufacturers developed a large family of stainless steels that has served the chemical, energy, food, and other industries very well. The modern era of stainless steels began in the early 1970s when steelmakers introduced new refining and casting technologies. These technologies allowed steel designers and producers to both improve existing “standard grades” and develop new grades with improved performance, including the new HPASS grades.

The new steel-making technologies included argon-oxygen decarburization (AOD) and vacuum-oxygen decarburization (VOD) processes. They make it economically possible to achieve very low carbon content, high alloy recovery, and better composition control (especially precise control of nitrogen content). Electroslag remelting (ESR), occasionally performed as an alternative or supplemental process, provides improved cleanliness control and a more homogenous microstructure containing fewer inclusions. Continuous casting increased efficiency, further reducing production costs.

These advances in steel-making lowered the cost of the standard low-carbon grades such as 304L and 316L, allowing for improved corrosion resistance of as-welded components. The first HPASS to take advantage of the new technologies, was 904L (N08904) developed by what is now Outokumpu. The 904L grade employs very low carbon levels to produce a weldable wrought version of an existing cast alloy which has very high resistance to strong reducing acids. In 1973, Allegheny Ludlum, now a subsidiary of ATI, introduced the first fully seawater-resistant austenitic stainless



Heat exchanger tubesheet during fabrication. © Sandvik

steel, AL-6X® (N08366), containing 6% Mo and very low carbon to achieve weldable thin sheet and tubing products. By the mid-seventies, developments in the use and control of nitrogen led to improved 6% Mo alloys that were weldable in thick sections and resistant to the formation of detrimental intermetallic phases that reduce pitting resistance. A list of the UNS numbers for these nitrogen-bearing 6% Mo grades and associated producers trade names are presented on page 93.

The increasing need for cost-effective, high-performance alloys in emerging environmental and energy industries pushed the required corrosion performance of stainless steels even higher in the 1990s. Three grades alloyed with approximately 7% Mo and relatively high

levels of N were developed and provide extremely high pitting resistance in aggressive chlorinated water. Included in this group of highly alloyed grades are S32654, S31266, and S31277. They approach the performance of some of the highly corrosion-resistant nickel alloys at significantly lower cost. For a list of the 7% Mo grades and the associated producers trade names see page 93.

**Table 1** shows the chemical composition for some of the more common standard 300 series and 200 series austenitic stainless steels. The high performance austenitic stainless steels are presented in **Table 2**. The HPASS contain chromium, nickel and molybdenum contents well above those of the standard 18% Cr-8% Ni grades. Many also contain nitrogen additions.

Table 1: Chemical composition\* (weight %) and PREN of some common standard wrought 300 and 200 series austenitic stainless steels\*\*.

Grade	UNS No.	EN No.	C	Mn	N	Cr	Ni	Mo	Cu	Other	PREN***
<b>Representative standard grades – 300 series</b>											
304	S30400	1.4301	0.07	2.00	0.10	17.5 19.5	8.0 10.5	–	–	–	18–20
304L	S30403	1.4307	0.03	2.00	0.10	17.5 19.5	8.0 12.0	–	–	–	18–21
321	S32100	1.4541	0.08	2.00	0.10	17.0 19.0	9.0 12.0	–	–	Ti 5x(C+N)min 0.70 max	18–21
347	S34700	1.4550	0.08	2.00	0.10	17.0 19.0	9.0 13.0	–	–	Nb 10xC min 1.00 max	18–21
316	S31600	1.4401	0.08	2.00	0.10	16.0 18.0	10.0 14.0	2.00 3.00	–	–	24–26
316L	S31603	1.4404	0.03	2.00	0.10	16.0 18.0	10.0 14.0	2.00 3.00	–	–	24–26
–	–	1.4435	0.03	2.00	0.11	17.0 19.0	12.5 15.0	2.50 3.00	–	–	27–29
317L	S31703	1.4438	0.03	2.00	0.10	18.0 20.0	11.0 15.0	3.00 4.00	–	–	29–30
<b>Representative standard grades – 200 series</b>											
201	S20100	1.4372	0.15	5.5 7.5	0.25	16.0 18.0	3.5 5.5	–	–	–	17–20
201L	S20103	–	0.03	5.5 7.5	0.25	16.0 18.0	3.5 5.5	–	–	–	17–20
201LN	S20153	–	0.03	6.4 7.5	0.10 0.25	16.0 17.5	4.0 5.0	–	1.0	–	17–20

Notes:

\* Taken from ASTM specifications for plate, sheet and strip when available or from company data sheets. For complete compositional requirements consult these sources.

\*\* Chemistry maximum, unless range or minimum is indicated, EN chemistry does not correspond exactly to ASTM chemistry

\*\*\* Pitting Resistance Equivalent Number calculated from the expression  $PREN = \%Cr + 3.3(\%Mo + 0.5\%W) + 16(\%N)$  and expected nominal chemical compositions for the grade

Table 2: Chemical composition\* (weight %) and PREN of common high performance austenitic stainless steels\*\*.

Grade	UNS No.	EN No.	C	Mn	N	Cr	Ni	Mo	Cu	Other	PREN***
Alloy 20	N08020	2.4660	0.07	2.00	–	19.0 21.0	32.0 38.0	2.00 3.00	3.00 4.00	(Nb+Ta): 8xC min, 1.00 max	25–27
317LM	S31725	–	0.03	2.00	0.20	18.0 20.0	13.2 17.5	4.00 5.00	–	–	30–32
317LMN	S31726	1.4439	0.03	2.00	0.10 0.20	17.0 20.0	13.5 17.5	4.00 5.00	–	–	31–33
904L	N08904	1.4539	0.02	2.00	0.10	19.0 23.0	23.0 28.0	4.00 5.00	1.00 2.00	–	33–35
–	S31727	–	0.03	1.00	0.15 0.21	17.5 19.0	14.5 16.5	3.80 4.50	2.80 4.00	–	33–35
–	N08028	1.4563	0.02	2.00	0.15 0.25	26.0 28.0	30.0 34.0	3.00 4.00	–	–	38–40
–	S34565	1.4565	0.03	5.00 7.00	0.40 0.60	23.0 25.0	16.0 18.0	4.00 5.00	–	–	45–47
–	N08026	–	0.03	1.00	0.10 0.16	22.0 26.0	33.0 37.2	5.00 6.70	2.00 4.00	–	41–43
–	S32053	–	0.03	1.00	0.17 0.22	22.0 24.0	24.0 26.0	5.00 6.00	–	–	41–43
–	N08926	1.4529	0.02	2.00	0.15 0.25	19.0 21.0	24.0 26.0	6.00 7.00	0.50 1.50	–	41–43
–	S31254	1.4547	0.02	1.00	0.18 0.22	19.5 20.5	17.5 18.5	6.00 6.50	–	–	41–43
–	N08367	–	0.03	2.00	0.18 0.25	20.0 22.0	23.5 25.5	6.00 7.00	0.75	–	43–45
–	S31266	1.4659	0.03	2.00 4.00	0.35 0.60	23.0 25.0	21.0 24.0	5.20 6.20	1.00 2.50	W: 1.5–2.5	48–59
–	S31277	–	0.02	3.00	0.30 0.40	20.5 23.0	26.0 28.0	6.50 8.00	0.50 1.50	–	47–49
–	N08031	1.4562	0.02	2.00	0.15 0.25	26.0 28.0	30.0 32.0	6.00 7.00	1.00 1.40	–	48–50
–	N08354	–	0.03	1.00	0.17 0.24	22.0 24.0	34.0 36.0	7.00 8.00	–	–	48–50
–	N08935	–	0.03	1.20	0.25 0.36	26.0 28.0	34.0 36.0	6.10 7.10	0.4	–	50–53
–	S32654	1.4652	0.02	2.00 4.00	0.45 0.55	24.0 26.0	21.0 23.0	7.00 8.00	0.30 0.60	–	54–56

Notes:

\* Taken from ASTM specifications for plate, sheet and strip when available or from company data sheets. For complete compositional requirements consult these sources.

\*\* Chemistry maximum, unless range or minimum is indicated, EN chemistry does not correspond exactly to ASTM chemistry

\*\*\* Pitting Resistance Equivalent Number calculated from the expression  $PREN = \%Cr + 3.3(\%Mo + 0.5\%W) + 16(\%N)$  and expected nominal chemical compositions for the grade

# 3 Metallurgy

## 3.1 Types of stainless steels

Stainless steels are iron-based alloys containing at least 10.5% Cr, which are used primarily for their corrosion resistance and high temperature properties. At this chromium level, a chromium-enriched surface oxide, called the passive layer or passive film, forms on the steel. This film protects the stainless steel and keeps it from “rusting” like ordinary steel. There are many different stainless steels, but they all meet this minimum chromium requirement.

Stainless steels belong to one of five major categories: austenitic, ferritic, duplex (mixed ferritic and austenitic), martensitic, and precipitation-hardening. These categories are related to the steels’ crystal structure (its arrangement of atoms) and its heat treatment. In a metal, groups of crystals having the same crystal structure are called phases. The three primary phases present in stainless steels are austenite, ferrite, and martensite. The microstructure of a stainless steel can be identified and quantified using standard metallographic procedures and an optical metallurgical microscope.

The austenitic stainless steels are characterized by having a microstructure that is primarily austenite phase. Austenite phase has a face-centered cubic (fcc) crystal structure which means that the main atoms are located at the corners and face centers of a cubic lattice. In comparison, the ferrite phase has a body-centered cubic (bcc) crystal structure with atoms located at the corners and center of a cubic lattice. The martensite phase has a highly strained body centered tetragonal crystal structure (**Figure 1**).

### 3.1.1 Austenitic stainless steel

As a family, the austenitic stainless steels tend to be non-magnetic, and have a moderate yield strength, high work hardening rate, high tensile strength, good ductility and excellent low-temperature toughness. Unlike other stainless steels, the austenitic stainless steels show a gradual reduction in toughness with decreasing temperatures (**Figure 2**). This lack of a well-defined ductile-to-brittle transition temperature (DBTT) makes austenitic stainless steels ideal candidates for cryogenic applications.

Austenitic stainless steels have good weldability and are readily fabricated into complex shapes. This family of stainless steels cannot be hardened or strengthened by heat treatment but can be strengthened by cold forming or work hardening (see ASTM A666). One potential disadvantage of the austenitic stainless steels, particularly the standard grades, is their susceptibility to chloride stress corrosion cracking compared to ferritic and duplex stainless steels.

The 300 series or standard austenitic stainless steels typically contain 8 to 11% nickel and 16 to 20% chromium (see Table 1). The microstructure of standard austenitic grades consists primarily of austenite grains with a small amount (typically 1 to 5 volume %) of delta ferrite phase (**Figure 3**). Because of the presence of the ferrite phase, these stainless steels are slightly ferromagnetic.

The 200 series austenitic stainless steels contain a lower level of Ni and higher levels of manganese (Mn) and N than 300 series stainless steels. This subgroup tends to have higher strength levels and greater strain hardening coefficients

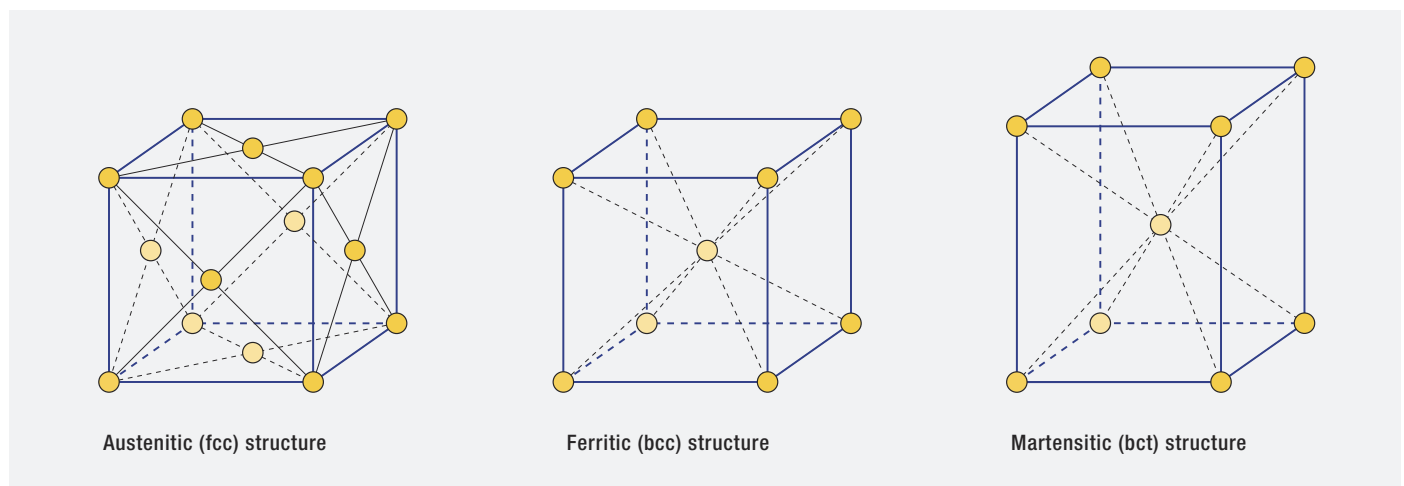

Figure 1: Crystal structure of the austenite phase which has a face-centered cubic (fcc) lattice, ferrite phase which has a body-centered cubic (bcc) lattice, and martensite phase which has a body centered tetragonal (bct) lattice.



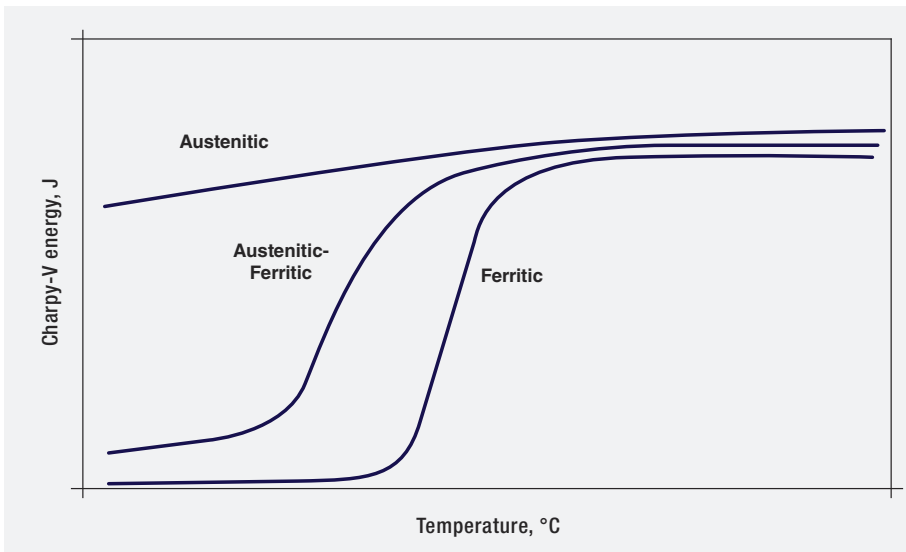

Figure 2: Schematic representation of the DBTT for austenitic, ferritic, and duplex (austenitic-ferritic) stainless steels. (1) The actual DBTT depends on section thickness, chemical composition and grain size. Ferritic stainless steels typically show a DBTT in the range of 0 to -25°C (32 to -13°F).

to chloride stress corrosion cracking than the standard 300 series austenitic grades. However, they do have reduced formability and weldability. They have reduced toughness compared to austenitic stainless steels and the toughness will decrease with increasing section thickness. Ferritic stainless steels also show a distinct ductile-to-brittle transition with decreasing temperature (Figure 2). Because of these limitations, they are usually restricted to thinner components such as sheet, strip, and thin-walled tubing.

### 3.1.3 Duplex stainless steel

Duplex stainless steels contain roughly equal portions of the ferrite and austenite phases and offer many properties between those provided by ferritic and austenitic stainless steels. Although this family of steels cannot be hardened by heat treatment, they typically have twice the yield strength of standard austenitic stainless steels and they have a magnetic attraction proportional to the volume fraction of the ferrite phase. The dual nature of their microstructure also provides better stress corrosion cracking resistance compared to standard austenitic stainless steels.

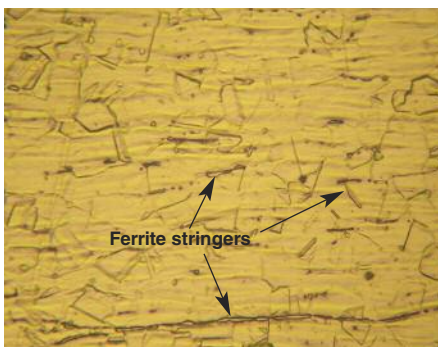

Figure 3: Microstructure of a typical wrought 304L stainless steel consisting of austenite grains and occasional ferrite stringers. © TMR Stainless

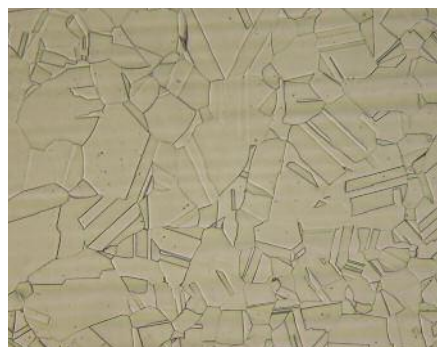

Figure 4: Microstructure of a 6% Mo HPASS consisting entirely of austenite grains. © TMR Stainless

than 300 series grades. Because of the lower nickel contents the 200 series grades are sometimes considered a lower cost alternative to the 300 series stainless steels.

HPASS have a microstructure that is fully austenitic and is not ferro-magnetic (Figure 4). Compared to standard austenitic grades HPASS contain higher levels of nickel, chromium, molybdenum, and typically nitrogen. These grades are designed to provide increased corrosion resistance to aggressive environments such as stronger acids, bases, and higher chloride-containing environments including brackish waters, seawater,

and brines. As a group HPASS tend to have higher strength levels and improved resistance to stress corrosion cracking compared to standard grades.

### 3.1.2 Ferritic stainless steel

Ferritic stainless steels have a microstructure that consists of ferrite phase. As a family, ferritic stainless steels have very low or no nickel content, are ferromagnetic, and cannot be hardened by heat treatment. This group of stainless steels has ferromagnetic properties similar to carbon steels. Ferritic stainless steels tend to have good strength and much better resistance

### 3.1.4 Martensitic stainless steel

The martensitic family of stainless steels has a microstructure that consists predominately of the martensite phase and possibly small amounts of secondary phases such as ferrite, austenite, and carbides. This family of stainless steels is ferromagnetic, similar to carbon steel. The final hardness depends on the specific heat treatments. Martensitic stainless steels have high strength, good wear resistance, low toughness, and a relatively high ductile-to-brittle transition temperature. They are very difficult to weld and typically require a post-weld heat treatment. Because of this, the martensitic grades are often restricted to non-welded applications. Martensitic grades do not have very high Cr levels and some of the Cr that is present is precipitated as carbides. This results in relatively low corrosion resistance,

typically below that of standard 304/304L austenitic grades. Because of their limited toughness and corrosion resistance, the martensitic grades are specified for applications that require very high strength and hardness such as cutlery, fasteners, and shafts.

### 3.1.5 Precipitation hardening stainless steel

The Precipitation Hardening (PH) stainless steels can also be strengthened by heat treatment. The defining characteristic of this family of stainless steels is that they rely on a precipitation mechanism for some of their strengthening. An age-hardening heat treatment is used to produce fine intermetallic precipitates that provide increased strength. Because of their higher Cr levels, the PH grades have better corrosion resistance than the martensitic grades and are used for high strength applications that require more corrosion resistance. Common applications for the PH grades include springs, fasteners, aircraft fittings, shafts, gears, bellows, and jet engine parts.

## 3.2 Phase Constituents

Alloying elements affect the equilibrium phase relationships and have a strong influence on the stability of austenite, ferrite, and martensite phases. The elements that are added to stainless steels can be divided into those that promote either ferrite or austenite phase. The phase balance is dependent on the chemical composition of the steel, the annealing temperature and the cooling rate. Properties such as resistance to corrosion, strength, toughness, weldability, and formability can be affected by the phase balance.

Ferrite-forming elements foster formation of ferrite, while austenite-forming elements promote the formation of austenite. **Table 3** lists the common ferrite and austenite forming elements. The desired phase balance depends on the grade of stainless steel and its application. Most of the standard austenitic grades have a small amount of ferrite present in the solution annealed condition for

**Table 3: Alloy additions that promote formation of ferrite and austenite.**

Ferrite formers	Austenite formers
Chromium	Nickel
Molybdenum	Nitrogen
Silicon	Carbon
Niobium (Columbium)	Manganese
Aluminum	Copper
Titanium	Cobalt
Tungsten	

improved weldability and high temperature ductility. However, if the ferrite content is too large it can degrade other properties such as corrosion resistance and toughness. The HPASS are designed to be completely austenitic in the solution annealed condition.

Controlling the steel's phase constituents, and therefore its properties, demands a balance of the alloying elements. The Schaeffler Diagram (**Figure 5**) is a tool that shows the relationship between the chemical composition and the expected phases present in a stainless steel in the as-solidified condition, as might be found in a weld. It allows the user to predict the phase balance from a given chemical composition. The composition is used to calculate the "nickel equivalent" and the "chromium equivalent" which can be plotted on the diagram. The equations for these parameters that are commonly used with the Schaeffler diagram are as follows:

$$\text{Ni-Equivalent} = \% \text{Ni} + 30\% \text{C} + 0.5\% \text{Mn} + 30\% \text{N}$$

$$\text{Cr-Equivalent} = \% \text{Cr} + \% \text{Mo} + 1.5\% \text{Si} + 0.5\% \text{Nb}$$

A typical HPASS containing about 20% Cr, 6% Mo, 20% Ni and 0.2% N, is located on the diagram in the single-phase Austenite region, near the

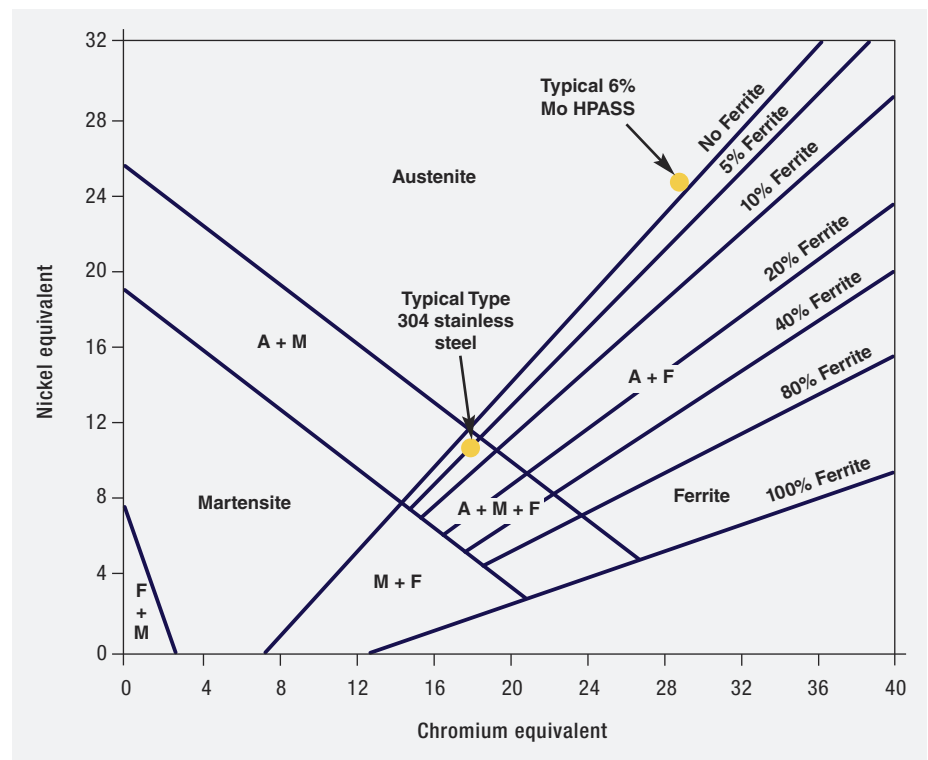

**Figure 5: The Schaeffler Diagram shows the influence of chemical composition on the amount of ferrite and austenite in the microstructure of as-cast weld metal. (2)**

“No Ferrite” line at a Nickel Equivalent of about 24 and a Chromium Equivalent of about 26. For comparison, a standard grade such as 304 has a composition that plots just inside the two-phase austenite + ferrite (A+F) region corresponding to a small volume of ferrite (Figure 5). Ferritic steels are designed to fall within the Ferrite region of this diagram, and duplex steels fall within the two-phase (A+F) region.

### 3.3 Detrimental secondary phases

The ideal microstructure of HPASS is a homogeneous array of austenite grains without any secondary phases. The ideal microstructure of the standard grades is the same except for possibly a small volume fraction of ferrite. However, these ideal conditions are in most cases not the equilibrium condition for austenitic stainless steels. Other, secondary phases can form when stainless steels are exposed to elevated temperatures, and they are usually detrimental to properties. The producer and the fabricator must closely control welding, heat treatments and other fabrication parameters to avoid formation of these detrimental secondary phases. All austenitic stainless steels have some susceptibility to the formation of secondary phases. However, because of their high alloy content, HPASS are particularly susceptible to secondary phase formation. Therefore, a thorough understanding of the formation and control of these phases is essential to the successful use of HPASS.

The specific secondary phase that will form depends on the composition of the stainless steel and its thermal history. In the standard 200 and 300 series grades, chromium carbide ( $Cr_{23}C_6$ ) is the primary concern. In the 425–900°C (800 – 1650°F) temperature range chromium carbides can precipitate on the boundaries of the austenite grains. Extensive precipitation creates a continuous network of carbides along the grain boundaries. To form chromium carbides, carbon and chromium from the stainless steel matrix combine and precipitate on the grain boundary (where it is energetically more favorable to

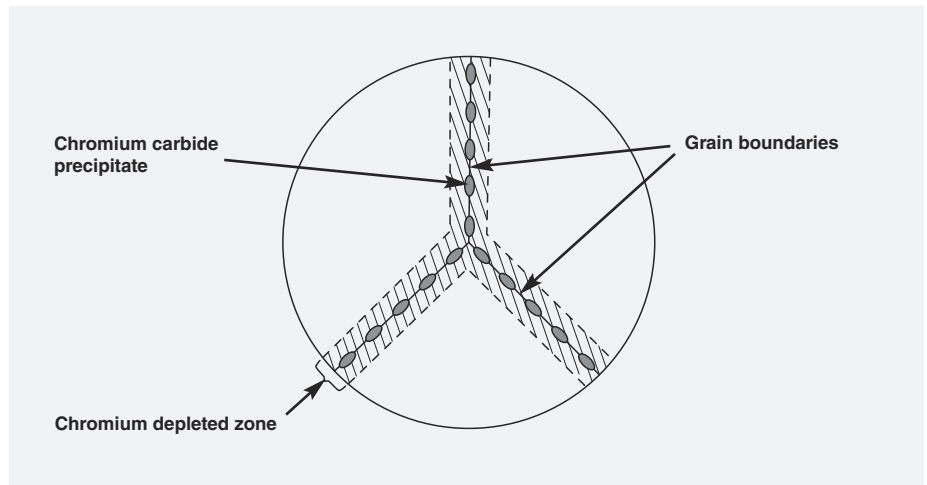

Figure 6: Schematic representation of sensitized grain boundaries in an austenitic stainless steel. (3)

nucleate and grow chromium carbide precipitates). Therefore, the area immediately adjacent the carbides, along the grain boundaries, has a lower chromium content than the bulk material and consequently a lower corrosion resistance. This phenomenon, termed “sensitization,” is well known and understood. **Figure 6** shows a schematic representation of a sensitized microstructure with grain boundary precipitates and the associated chromium-depleted zone.

Similar phenomena occur with other secondary phases but the temperatures and times involved are different. Two important secondary phases, affecting HPASS, are sigma and chi. These phases are called intermetallic compounds because they are more like a chemical compound than a metal. They contain very high chromium and/or molybdenum content in addition to iron, are brittle, and can reduce corrosion resistance by depleting adjacent areas of chromium or molybdenum. The following sections discuss conditions that lead to their formation and control.

#### 3.3.1 Temperature of secondary phase stability

At or above the solution annealing temperature, carbides and intermetallic compounds dissolve and remain in

solution. Below that temperature one or more secondary phases can precipitate, depending on the chemical composition of the stainless steel. In Type 304, for example, chromium carbides start to form below about 900°C (1650°F). With higher alloy content, the tendency to form other secondary phases increases, as does the temperature below which they can form. In some of the very highly alloyed HPASS, chi phase can form at temperatures as high as 1095°C (2000°F). This means that HPASS must be solution annealed at significantly higher temperatures than standard grades, usually above 1095°C (2000°F) to optimize the corrosion resistance.

#### 3.3.2 Kinetics of secondary phase formation

The kinetics or rate at which secondary phases form on cooling is a very important factor to consider for the successful annealing and welding of these steels. Regardless of the grade, stainless steels must be quenched rapidly enough to avoid the formation of secondary phases. To illustrate the relationship between cooling rate and grade, consider standard Type 304 stainless steel and its most likely secondary phase, chromium carbide. As demonstrated by the time-temperature-transformation (TTT) curve for the initiation of grain boundary chromium

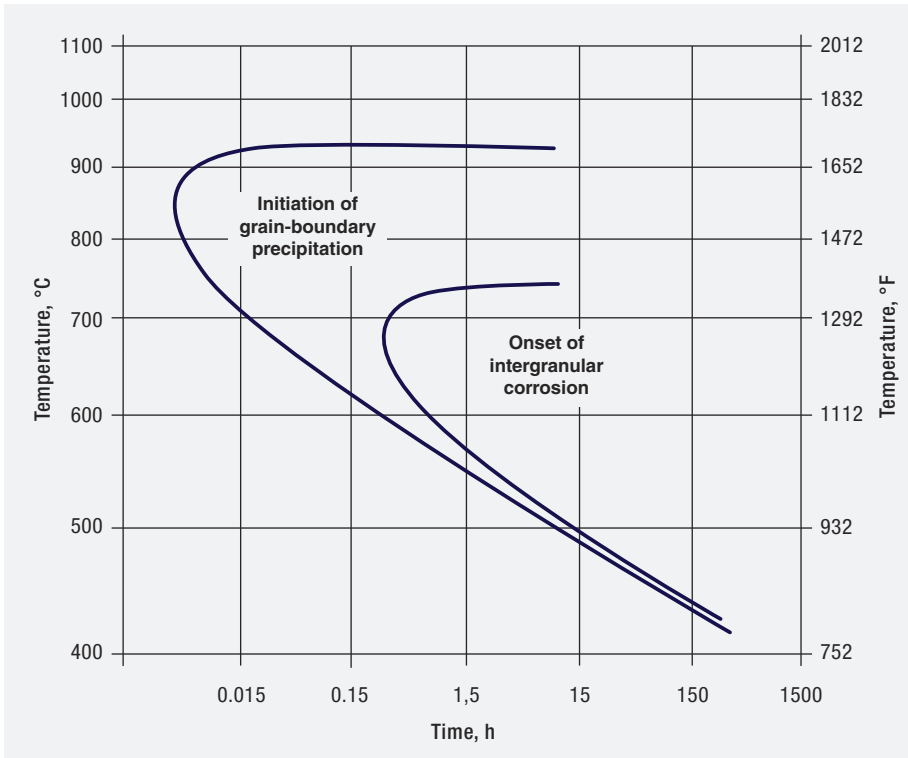

Figure 7: TTT curve for a Type 304 stainless steel containing 0.05% C, showing the initiation of grain boundary carbide precipitation and the corresponding TTS curve for the onset of intergranular corrosion detected with a  $H_2SO_4-Cu_2SO_4$  test. (4)

carbide precipitation shown in **Figure 7**, carbide begins to form on cooling to temperatures below about  $900^{\circ}C$  ( $1650^{\circ}F$ ). The rate at which carbides form increases rapidly with decreasing temperature until about  $850^{\circ}C$  ( $1560^{\circ}F$ ), where it is very high. As the temperature cools below  $850^{\circ}C$  ( $1560^{\circ}F$ ) the kinetics of carbide formation slows due to slower diffusion of chromium atoms to grain boundaries with reduced temperature and the time for the initiation of carbide formation becomes longer. The loss of corrosion resistance associated with the chromium carbide precipitation can also be mapped as demonstrated by the corresponding time-temperature-sensitization (TTS) curve shown in Figure 7. The TTS curve shows that Type 304 must be cooled rapidly to temperatures well below  $700^{\circ}C$  ( $1300^{\circ}F$ ) to avoid a reduction in corrosion resistance.

The time-temperature range for the loss of corrosion resistance (TTS curve) in Figure 7 is offset from the time temperature range for the precipitation of the carbides (TTT curve) particularly at higher temperatures. This difference between the TTT and TTS curves is related to the higher rate of Cr diffusion at higher temperatures, which allows Cr-depleted zones to be healed by back diffusion at these higher temperatures hence, no loss of corrosion resistance.

**Figure 8** shows TTS curves for a number of Type 304 stainless steels with a variety of carbon contents, which reveal important features of sensitization. Chromium carbide precipitation kinetics are much slower in steels with lower carbon contents. From a practical standpoint, the curves show that when annealing or welding these steels they must be cooled rapidly below the nose of the curves to avoid sensitization

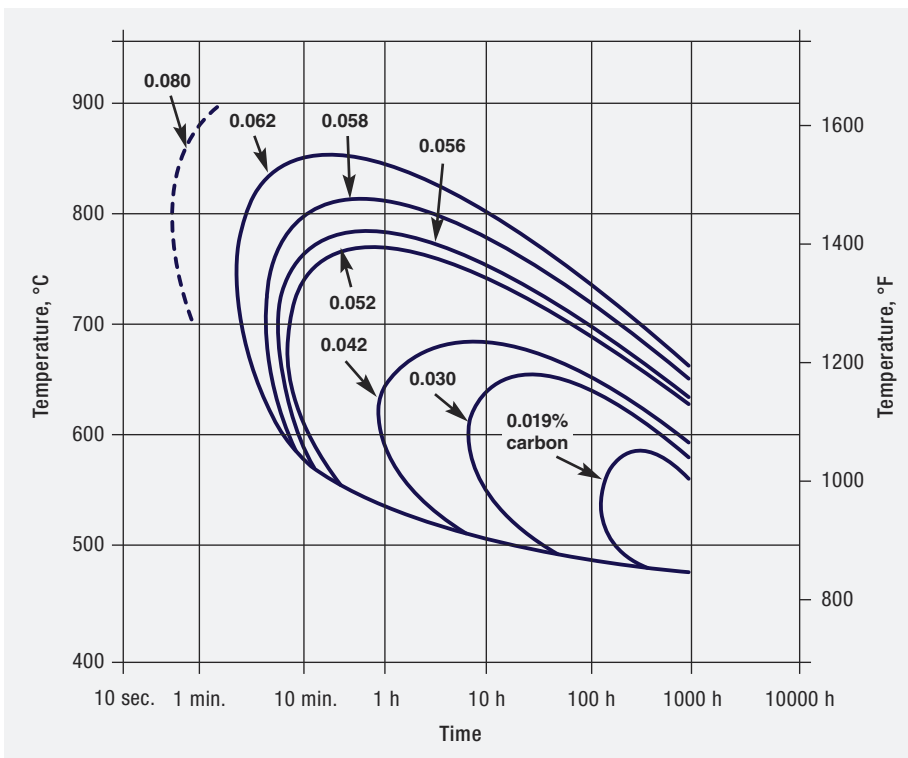

Figure 8: TTS diagram for Type 304 stainless steel with various carbon contents. (5)

and the associated danger of localized corrosion. Lowering the carbon content extends the available time for cooling, making it easier to avoid sensitization.

The use of a low carbon level to minimize sensitization is a common practice and the “L-grades” such as Types 201L, 304L, and 316L were developed to provide protection from sensitization during welding. An alternative approach to protect against sensitization is to stabilize the stainless steel with titanium (Ti) or niobium (Nb). These elements in grades such as Type 321 or 347 are used to preferentially form titanium and niobium carbides, making the carbon unavailable for chromium carbide precipitation. The nitrogen modified standard grades also have the benefit of a slower chromium carbide precipitation rate, which provides improved resistance to sensitization.

A TTT diagram for Type 316 stainless steel containing 2% Mo and a carbon content of 0.066% (Figure 9), shows that in such a grade chromium carbide can form in as little as five minutes, but secondary phases such as sigma, chi and Laves only form after a much longer time (typically 10 hours or longer). In contrast, with HPASS the precipitation of sigma and chi phases is of greater concern than chromium carbide. This is due to the low carbon content of HPASS, which reduces their susceptibility to chromium carbide sensitization and due to their high chromium and molybdenum contents, which promote rapid formation of sigma and chi intermetallic phases. The TTS diagram for a 6% Mo HPASS, shown in Figure 10, maps the time and temperature required for the start of grain boundary precipitation of sigma and chi phases as well as those required for decoration of 50% of the grain boundaries with precipitates.

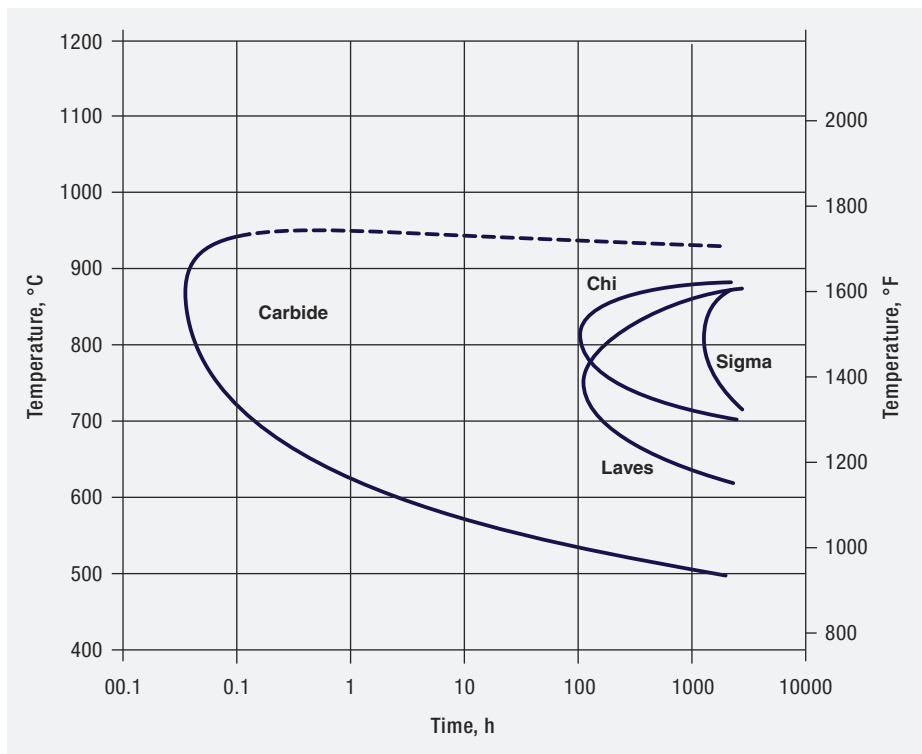

Figure 9: TTT diagram for Type 316 stainless steel with 0.066% carbon content. Secondary phases chi, sigma and Laves take a long time to develop in this standard grade. (6)

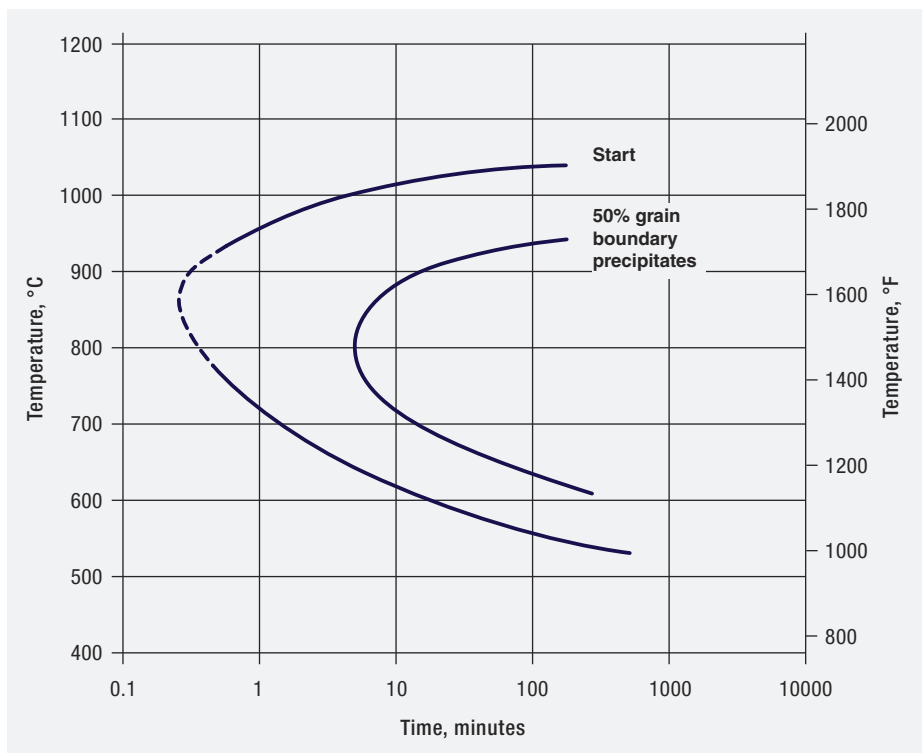
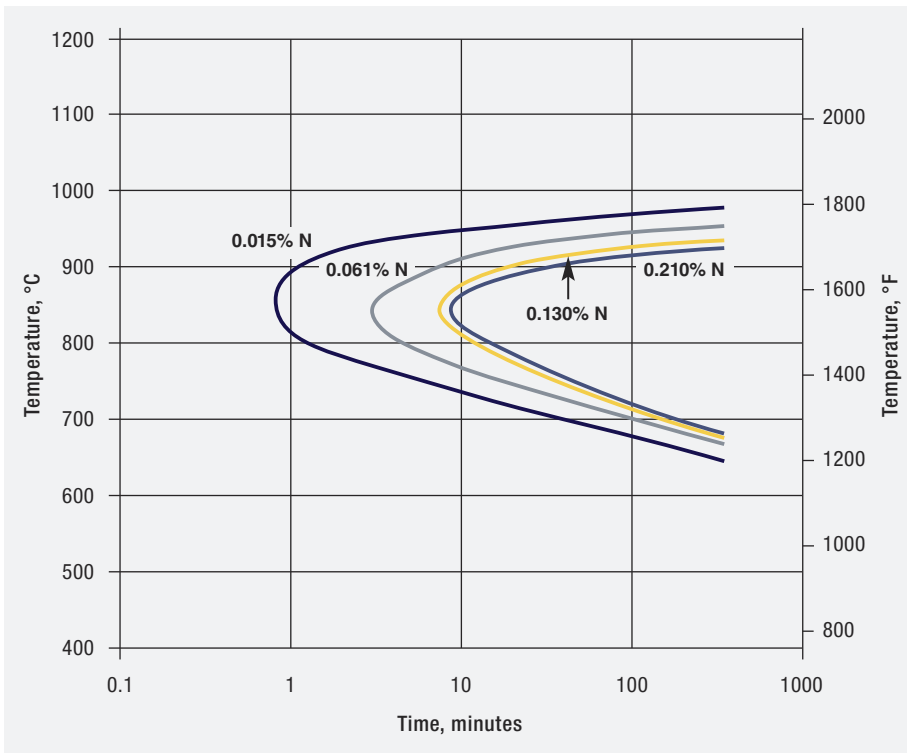

Figure 10: TTS diagram for a 6% Mo stainless steel, S31254, determined by the occurrence of grain boundary ditching after electrolytic etching in 3M HClO<sub>4</sub> + 1M HCl solution at 28°C (82°F). (7)



As briefly noted earlier, nitrogen delays the formation of these phases. It also reduces the maximum precipitation temperature and decreases the amount of intermetallic phase in the structure (8). These effects are demonstrated in **Figure 11**. In this figure a 904L base stainless steel, alloyed with nitrogen contents varying from 0.015 to 0.210%, was investigated to determine the impact of the nitrogen content on sensitization kinetics. The delay of secondary phase precipitation with increasing nitrogen content allows for slower cooling after annealing or welding, reducing the risk of sensitization.

As chromium and molybdenum increase to very high levels in the most highly alloyed HPASS, intermetallic phases form at even shorter times. Nitrogen additions are helpful, but even very high nitrogen contents of 0.20–0.50% N are not able to shift the onset of precipitation to times in the desired range of ten minutes or more.

Figure 11: TTS Effects of nitrogen on the sensitization kinetic of a 904L stainless steel determined by oxalic acid etching. (8)

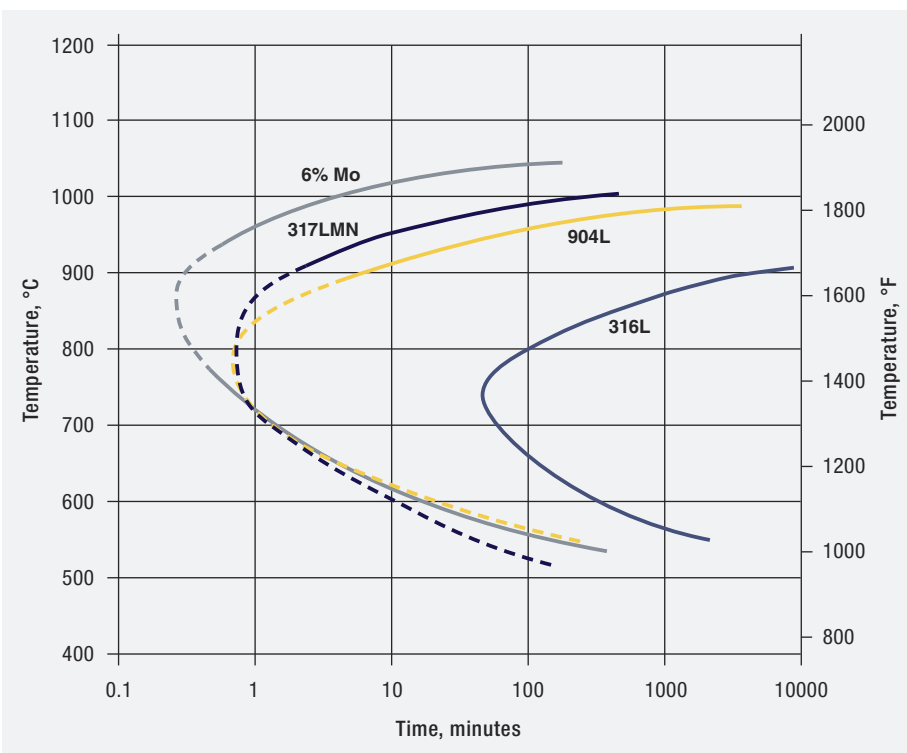

**Figure 12** shows representative TTS curves of several commercial alloys, developed using electrolytic etching techniques. (7) The increased molybdenum level in the higher alloyed stainless steels accelerates the onset of intermetallic phase precipitation, raises the maximum precipitation temperature and retards the precipitation of nitride phases. (8) As shown in Figure 12 the most highly alloyed stainless steels can suffer intermetallic phase formation in less than a minute. Clearly, alloys of this kind require limitations on section size and heat input during welding and well controlled rapid cooling to avoid secondary phase formation.

Figure 12: TTS diagram for several commercial austenitic stainless steels with different molybdenum and nitrogen contents. The Type 316L here is a high molybdenum variant with 0.021% C and 2.6% Mo and the 6% Mo grade is the same as in Figure 10. (7)

# 4 Role of alloying elements

Chemical composition has a major influence on a steel's metallurgical structure, mechanical properties, physical properties and corrosion resistance. Both intentional alloying elements and alloying elements unintentionally introduced by the steel-making process affect these properties.

Alloying elements such as chromium, molybdenum, and nickel are incorporated in the crystal lattice on substitutional sites. That is, they substitute for iron on the corners and face centers of the austenitic lattice. Carbon and nitrogen, because of their small size, locate themselves in open spaces (interstitial sites) between the lattice atoms. In doing so, they create large strains in the lattice and so are potent hardening elements. Alloying elements influence the steel's properties in different ways, sometimes beneficial, sometimes detrimental. Choosing a particular steel composition or grade often requires the designer or materials engineer to sacrifice a measure of one property to maximize the benefit of another. The following sections describe the function of important alloying elements in austenitic stainless steels.

## 4.1 Chromium (Cr)

Chromium is the alloying element that makes stainless steels "stainless". At least 10.5% Cr is required to produce the unique surface passive film responsible for this characteristic. The passive film is effective in protecting the stainless steel in environments that can include aggressive waters, many acids and even highly oxidizing high-temperature gases. Corrosion resistance improves in a wide variety of environments as chromium increases above the threshold level of 10.5%. For this reason many grades have chromium levels well above that amount. Examples are the workhorse Type 304 grade with 18% Cr and the HPASS with 20–28% Cr.

## 4.2 Nickel (Ni)

Nickel's primary purpose is to create and stabilize austenite. Without 8% Ni, Type 304 would not be an austenitic stainless steel and would not exhibit austenite's desirable mechanical properties. Instead, it would be a ferritic stainless steel with different strength and toughness levels. As more chromium or other ferrite-forming elements are added to the steel, more nickel is needed to maintain the austenitic structure. HPASS, which have high chromium and molybdenum contents, require nickel levels of about 20% to preserve the austenitic structure. Nickel also improves corrosion behavior in certain reducing acids, and increases stress corrosion cracking resistance above about 20%. It also reduces the rate of work hardening during cold deformation, so it is often found at elevated levels in alloys designed for deep drawing, spin forming and cold heading.

## 4.3 Molybdenum (Mo)

Molybdenum increases resistance to pitting and crevice corrosion in chloride-containing environments. It works synergistically with chromium and especially nitrogen to improve performance in these environments. This synergistic effect produces very high pitting and crevice corrosion performance in HPASS. Molybdenum also increases corrosion resistance in reducing environments such as hydrochloric acid and dilute sulfuric acid. The minimum molybdenum addition to austenitic stainless steels is about 2%, as in Type 316. The most highly alloyed HPASS steels contain up to 7.5% Mo.

Molybdenum promotes ferrite formation, which affects phase balance. It participates in the formation of several detrimental secondary phases, and forms an unstable high temperature oxide,

adversely affecting high temperature oxidation resistance. These factors must also be considered when using stainless steels containing molybdenum.

## 4.4 Carbon (C)

Carbon stabilizes and strengthens austenite, making it a useful alloying element in stainless steels for high-temperature applications, like boiler tubes. Carbon has no other useful function and can be detrimental to corrosion resistance under certain circumstances as noted earlier. The carbon content of most austenitic stainless steels is usually limited to the lowest practical levels. Standard low carbon grades designed for welding (Types 304L, 201L, and 316L) limit carbon to 0.030%. Some of the more highly alloyed high performance grades limit carbon even further to 0.020%.

## 4.5 Nitrogen (N)

Nitrogen stabilizes and strengthens austenite, and retards secondary phase formation. It is used in both standard grades and in HPASS. In low carbon standard (L-grades), it is added in small amounts (up to 0.1%) to offset the loss in strength due to the low carbon. In standard grades and HPASS, it provides strength and retards carbide sensitization and the formation of secondary phases. Nitrogen also improves resistance to chloride pitting and crevice corrosion, so some of the most corrosion resistant HPASS contain up to 0.5% N.

## 4.6 Manganese (Mn)

Steelmakers use manganese to deoxidize molten steel, so a small residual amount is found in all stainless steels. Manganese also stabilizes austenite and increases nitrogen solubility in stainless steel. It is therefore used to replace some of the nickel in the 200 series stainless



Austenitic stainless steel is widely used in the pharmaceutical industry. © iStock.com/4X-image

steels to allow higher nitrogen content resulting in improved strength and corrosion resistance. It is also added to some HPASS, for the same effects.

#### 4.7 Copper (Cu)

Copper improves the corrosion resistance of stainless steels in reducing acids like certain sulfuric acid and phosphoric acid mixtures. It is used as an alloying element in some HPASS that have been designed specifically for service in these environments.

#### 4.8 Silicon (Si)

Overall Si is beneficial to austenitic stainless steels because it can improve corrosion resistance in concentrated

acid environments and highly oxidizing environments. It has been reported that high-silicon specialty stainless steels such as UNS S30600 have improved pitting resistance. Like manganese, silicon is used to deoxidize molten steel, so a small amount is always present in the form of small oxide inclusions containing silicon, manganese and other deoxidizing elements. If the inclusion content becomes too large there can be a detrimental effect on the surface quality and polishability.

#### 4.9 Niobium (Nb) and titanium (Ti)

These elements are very strong carbide formers, and are used as alternatives to low carbon content to mitigate sensitization. The presence of Nb and

Ti carbides will improve high temperature strength. Types 347 and 321 containing Nb and Ti, are often used in boiler and refinery applications where elevated temperature strength and weldability are requirements. They are also used in certain deoxidation practices, so sometimes are found as residual elements in HPASS.

#### 4.10 Sulfur (S) and phosphorus (P)

Sulfur has both beneficial and detrimental effects on the properties of stainless steels. Its most important beneficial effect is improved machinability, while its major detrimental effects are reduced hot workability and its role in increasing the amount of manganese sulfide inclusions, which lowers the pitting resistance of stainless steel. The HPASS are intrinsically difficult to hot work, so they always contain the lowest practical sulfur content, about 0.001%. Sulfur is not normally used as an alloy addition in HPASS. However, higher sulfur levels (0.005–0.017%) are commonly used in standard grades to improve weld penetration for autogenous welding applications and to improve machinability.

Phosphorous has no beneficial effect, and is detrimental to hot workability during forging and hot rolling. It also promotes hot cracking during cooling after welding. It is always limited to the lowest practical level.



# 5 Mechanical and physical properties

As a family, austenitic stainless steels have good strength combined with excellent toughness. They get their strength by solid solution strengthening from both substitutional alloying elements and interstitial additions of nitrogen and carbon. Austenitic stainless steels cannot be hardened or strengthened by heat treatment and when higher strength is required it can only be achieved through cold working. Austenitic stainless steels have a relatively high work hardening coefficient and high work hardening rate so cold work significantly increases their strength. They have excellent formability and can absorb large amounts of energy before failure. These alloys retain good mechanical properties at both cryogenic and elevated temperatures.

## 5.1 Strength

**Table 4** summarizes room temperature mechanical properties for standard austenitic grades and HPASS. Compared to the standard 300 series austenitic stainless steels, the 200 series and HPASS have higher yield and tensile strength values. This is largely due to solid solution strengthening by interstitial N and C, but, also due to higher alloying with substitution elements such as Mo, Ni and Cr. **Figure 13** shows how nitrogen alloying raises the strength of these steels. For example, increasing nitrogen content from the normal level of 0.05% to 0.20% raises the yield strength from 270 MPa (39 ksi) to 340 MPa (49 ksi). This has a significant effect on the strength minimums in materials specifications. ASTM A240, for example, specifies a minimum yield strength of 170 MPa (25 ksi) for Type 304L (about 0.05% N), and 240 MPa (35 ksi) for Type 304N (0.15% N). A further step-up occurs for HPASS grades like S31254 (0.20% N) with a specified minimum yield strength of 310 MPa (45 ksi) and S31266 (0.50% N) with a minimum yield strength of 420 MPa (61 ksi).

Because austenitic stainless steels cannot be hardened by heat treatment, they are usually produced in the solution annealed condition. When higher strength is required some mill products are available in the cold rolled condition. Cold working processes like forming, spinning, swaging, and cold drawing can produce very high strength. A high work hardening rate can cause difficulty in some shop-forming operations where a section size limitation might occur for a given machine power. Intermediate annealing may be necessary to soften the stainless steel enough to allow further forming. High work hardening rates can also create problems during machining if the cutting tool hardens the surface of the workpiece. Low speeds and large depth of cut are recommended when machining austenitic stainless steels.

For a comparison of the influence of cold work on strength levels for a 300 series, a 200 series and a HPASS, see **Figure 14**.

The strength increase from cold work is retained at moderate temperatures, but not at high temperatures. So, a cold worked material does not retain its strength upon annealing or welding.

## 5.2 Ductility and toughness

Austenitic stainless steels have excellent ductility, with elongation values in the range of 60% to 70%, well above specification minimums. The nitrogen used to increase strength in some of the alloys does not reduce ductility. The face-centered-cubic crystal structure of austenite is responsible for the good

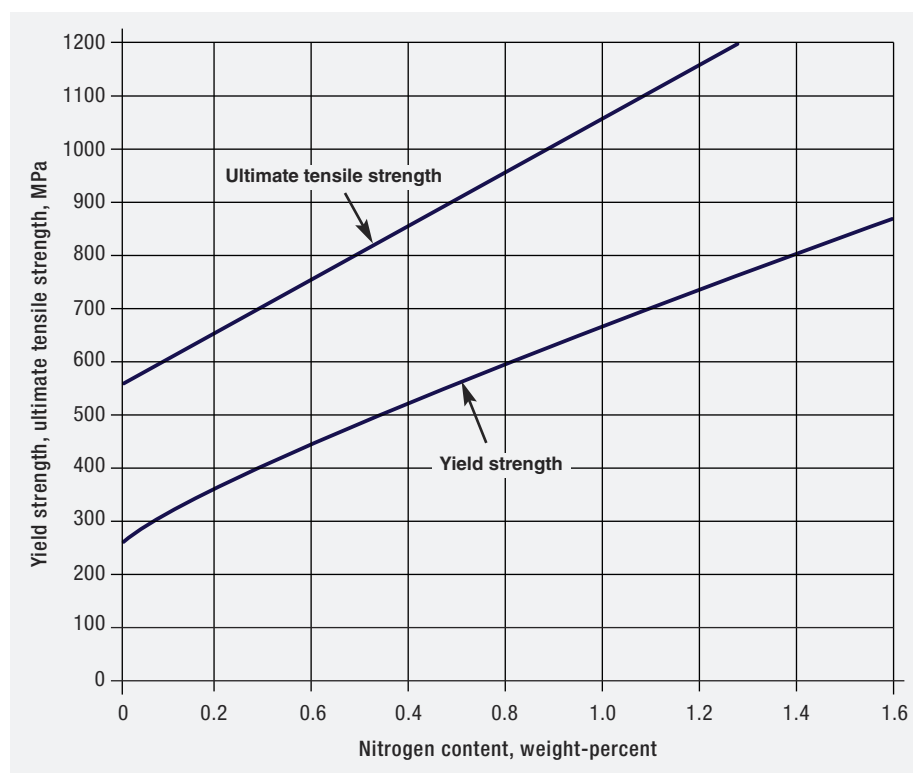

Figure 13: Effect of nitrogen on the strength of austenitic stainless steels. (9)

Table 4: Minimum mechanical properties of standard 300 and 200 series austenitic stainless steels and HPASS.

Grade	UNS No.	EN No.	Yield strength 0.2%		Tensile strength		Elongation in 2"	Hardness, max	
			MPa	ksi	MPa	ksi		%	Brinell
<b>Standard austenitic stainless steels – 300 series</b>									
304	S30400	1.4301	205	30	515	75	40	201	92
304L	S30403	1.4307	170	25	485	70	40	201	92
321	S32100	1.4541	205	30	515	75	40	217	95
347	S34700	1.4550	205	30	515	75	40	201	92
316L	S31603	1.4404	170	25	485	70	40	217	95
317L	S31703	1.4438	205	30	515	75	40	217	95
<b>Standard austenitic stainless steels – 200 series</b>									
201	S20100	1.4372	260	38	515	75	40	217	95
201L	S20103	–	260	38	655	95	40	217	95
201LN	S20153	–	310	45	655	95	45	241	100
<b>High performance austenitic stainless steels</b>									
Alloy 20	N08020	2.4660	240	35	550	80	30	217	95
317LM	S31725	–	205	30	515	75	40	217	95
317LMN	S31726	1.4439	240	35	550	80	40	223	96
904L	N08904	1.4539	220	31	490	71	35	–	90
–	S31727	–	245	36	550	80	35	217	–
–	N08028	1.4563	500	73	214	31	40	–	90
–	S34565	1.4565	415	60	795	115	35	241	100
–	N08026	–	241	35	551	80	30	217	95
–	S32053	–	295	43	640	93	40	217	96
–	N08926	1.4529	295	43	650	94	35	–	–
–	S31254	1.4547	310	45	655	95	35	223	96
–	N08367	–	310	45	655	95	30	241	–
–	S31266	1.4659	420	61	750	109	35	–	–
–	S31277	–	360	52	770	112	40	–	–
–	N08031	1.4562	276	40	650	94	40	–	–
–	N08354	–	295	43	640	93	40	217	96
–	N08935	–	425	62	750	109	35	–	–
–	S32654	1.4652	430	62	750	109	40	250	–

Note: These mechanical properties correspond to the grades of ASTM produced to the UNS designations shown. The grades identified by Euro Norm designation, as shown in the second column, are similar but may not be identical. Material certified as meeting the requirements of a specification within one system, e.g., ASTM, will not necessarily meet the requirements of the similar material in another specification, e.g., EN or JIS.

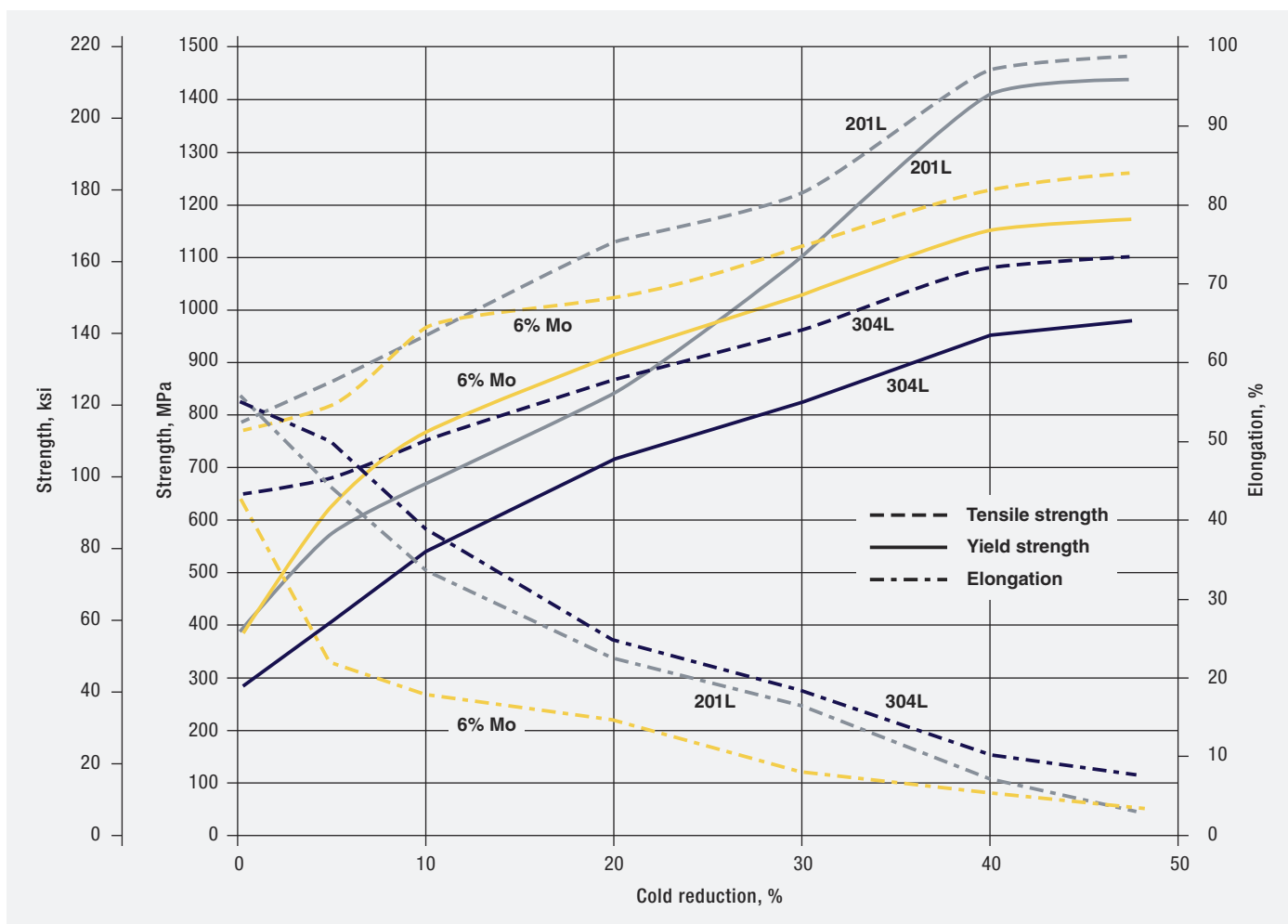

Figure 14: Effect of cold work on the strength and ductility of Type 201L, 304L and the 6% Mo HPASS N08367.

ductility, which in turn also produces very good toughness at ambient temperature and below. Unlike carbon steels and some other materials, austenitic stainless steels do not exhibit a distinct ductile-to-brittle transition with decreasing temperature and they are routinely used at cryogenic temperatures.

Although cold work reduces ductility and toughness, the loss of ductility is gradual and austenitic stainless steels with 20% cold reduction will typically still have 15% or more elongation (Figure 14). Cold work decreases ductility by increasing the dislocation density of the annealed starting material. Annealing, conversely, relieves the effects of cold working through recovery and recrystallization,

reducing strength and restoring ductility and toughness to high values.

### 5.3 High-temperature strength

Austenitic stainless steels deliver good strength at elevated temperatures. Most of the standard grades have been approved for pressure vessel applications. The ASME Pressure Vessel Code gives allowable design values to temperatures up to 427°C (800°F). For furnace applications, where pressure is not a factor, standard and some special heat resistant stainless grades can be used up to 1100°C (2010°F). The HPASS are designed primarily for corrosion resistance, but their strength advantage over standard grades at ambient

temperature is also retained at high temperature. For example, the ASME Code allowable stress for HPASS N08367 at 427°C (800°F) is 18 ksi (124 MPa), compared to Type 316 at 9.6 ksi (66 MPa). **Figure 15** compares high-temperature strength data for Type 316 stainless steel to those of three HPASS.

Besides their good high temperature strength, austenitic stainless steels have the advantage of not forming the embrittling alpha prime phase above about 300°C (570°F) as ferritic and duplex stainless steels do. However, the HPASS can form embrittling chi and sigma phases at temperatures in the 500–1050°C (930–1925°F) range.

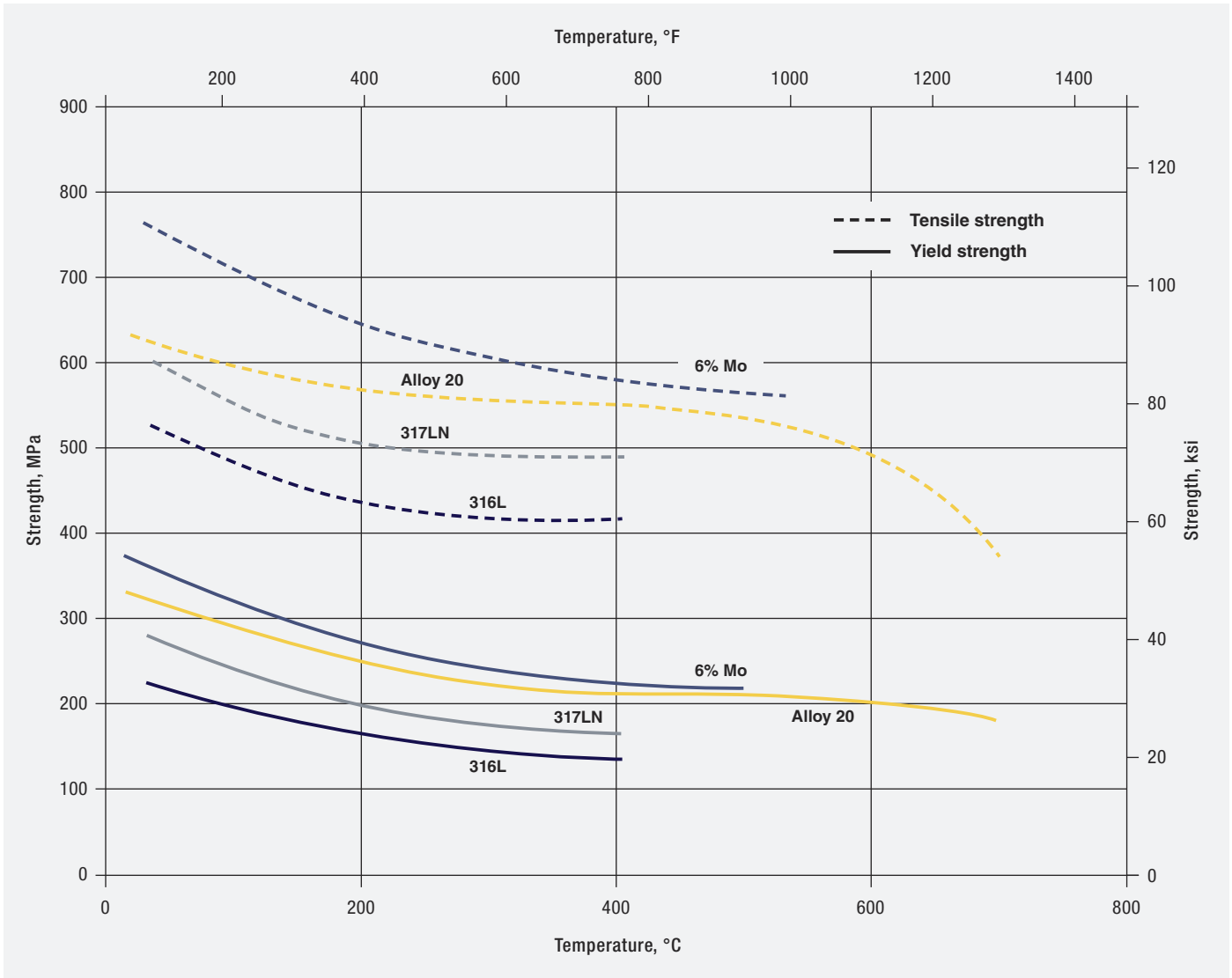

Figure 15: High temperature strength of three HPASS, Alloy 20, 317LN and UNS N08367, compared to Type 316L. (10)

Their good high-temperature strength can have both positive and negative effects on fabrication. When annealing a fabricated component, high strength at temperature prevents distortion of a workpiece under the influence of gravity. However, if a component does distort, for example during welding, high strength makes it more difficult to straighten than a lower strength component. As noted

earlier, high-strength alloys may exceed the available forming equipment power, limiting the section size that a given machine can form.

#### 5.4 Physical properties

Austenitic stainless steels all have similar physical properties. Compared to carbon steels they have a slightly lower

Young's modulus, higher coefficient of thermal expansion (CTE) and lower thermal conductivity. **Tables 5 and 6** summarize detailed physical property data for austenitic stainless steels.

Table 5: Ambient temperature physical properties of standard austenitic and HPASS.

Grade	UNS No.	Density		Specific heat		Electrical resistivity		Young's modulus	
		g/cm <sup>3</sup>	lb/in <sup>3</sup>	J/kg-K	Btu/lb/°F	Ω·mm <sup>2</sup> /m	micro Ω in	GPa	10 <sup>6</sup> psi
<b>Representative standard grades – 300 series</b>									
304L	S30403	8.03	0.290	500	0.120	0.72	28.3	193	28.0
321	S32100	7.89	0.285	500	0.120	0.72	28.3	193	28.0
347	S34700	7.97	0.288	500	0.120	0.73	28.7	200	29.0
316L	S31603	7.95	0.287	469	0.112	0.74	29.1	193	28.0
317L	S31703	7.95	0.287	460	0.110	0.79	31.1	200	29.0
<b>Representative standard grade – 200 series</b>									
201	S20100	7.86	0.284	502	0.120	0.67	26.4	207	30.0
<b>High performance austenitic stainless steels</b>									
Alloy 20	N08020	8.08	0.292	502	0.120	1.08	42.5	193	28.0
Alloy 825*	N08825	8.14	0.294	440	0.015	1.13	44.5	193	28.0
317LM	S31725	7.95	0.287	460	0.110	0.79	31.1	200	29.0
317LMN	S31726	8.02	0.290	502	0.112	0.85	33.5	200	29.0
904L	N08904	7.95	0.287	461	0.110	0.95	37.4	190	28.0
–	S31727	8.02	0.290	460	0.109	0.86	33.9	203	29.4
–	N08028	8.00	0.290	460	0.109	0.99	39.0	105	28.3
–	S34565	8.00	0.290	510	0.122	0.92	36.2	190	28.0
–	N08026	8.13	0.294	461	0.110	1.08	42.5	186	27.0
–	S32053	8.06	0.291	460	0.109	0.93	36.6	188	27.3
–	N08926	8.15	0.294	461	0.110	0.88	34.6	192	27.8
–	S31254	7.95	0.287	498	0.119	0.85	33.5	200	29.0
–	N08367	8.06	0.291	461	0.110	0.89	35.0	195	28.2
–	S31266	8.20	0.297	450	0.113	1.00	39.4	195	28.3
–	S31277	8.02	0.289	454	0.109	1.00	39.4	191	27.7
–	N08031	8.03	0.290	440	0.105	1.00	39.4	195	28.3
–	N08354	8.16	0.295	440	0.105	1.03	40.6	193	28.0
–	N08935	8.06	0.291	450	0.110	1.05	41.3	192	27.8
–	S32654	8.00	0.290	510	0.122	0.78	30.7	188	27.6

\* Alloy 825 is a nickel base alloy, not a stainless steel.

Table 6: Room and elevated temperature physical properties of standard austenitic and HPASS.

Grade	UNS No.	20°C (68°F)	100°C (212°F)	200°C (392°F)	300°C (572°F)	400°C (754°F)	500°C (932°F)
<b>Young's modulus in tension GPa (10<sup>6</sup> psi)</b>							
201	S20100	200 (29.0)	194 (28.1)	186 (27.0)	179 (26.0)	172 (24.9)	165 (23.9)
304	S30400	193 (28.0)	193 (28.0)	193 (28.0)	187 (27.1)	183 (26.5)	179 (26.0)
321	S32100	193 (28.0)	193 (28.0)	193 (28.0)	188 (27.3)	183 (26.5)	178 (25.8)
316L	S31603	200 (29.0)	194 (28.1)	185 (26.8)	177 (25.7)	169 (24.5)	160 (23.2)
317LMN	S31726	200 (29.0)	194 (28.1)	186 (27.0)	179 (26.0)	171 (24.8)	163 (23.6)
–	S34565	193 (28.0)	187 (27.1)	180 (26.1)	173 (25.1)	165 (23.9)	157 (22.9)
–	N08926	193 (28.0)	186 (27.0)	179 (26.0)	173 (25.1)	168 (24.4)	162 (23.6)
–	S32053	188 (27.3)	184 (26.7)	178 (25.8)	172 (24.9)	165 (23.9)	–
–	N08367	195 (28.3)	189 (27.4)	180 (26.1)	172 (24.9)	163 (23.6)	158 (23.0)
–	S31266	190 (27.6)	185 (26.8)	179 (26.0)	174 (25.2)	166 (24.1)	158 (23.0)
–	N08354	198 (28.7)	194 (28.1)	189 (27.4)	183 (26.5)	177 (25.7)	172 (24.9)
–	N08935	192 (27.8)	187 (27.1)	180 (26.1)	174 (25.2)	168 (24.4)	161 (23.4)
–	S32654	189 (27.4)	184 (26.7)	177 (25.7)	170 (24.7)	163 (23.6)	–
<b>Mean coefficient of thermal expansion - temperature 20°C (68°F) to T - 10<sup>-6</sup>/K (10<sup>-6</sup>/°F)</b>							
304	S30400	–	16.6 (9.20)	16.9 (9.40)	17.4 (9.65)	17.6 (9.75)	18.0 (10.00)
321	S32100	–	16.0 (8.89)	16.5 (9.17)	17.0 (9.44)	17.5 (9.72)	18.0 (10.00)
316L	S31603	–	16.5 (9.17)	16.9 (9.38)	17.3 (9.61)	17.6 (9.78)	18.0 (10.00)
201	S20100	–	16.6 (9.20)	–	–	–	–
Alloy 20	N08020	–	14.9 (8.27)	15.2 (8.44)	15.5 (8.61)	15.9 (8.83)	16.1 (8.94)
317LMN	S31726	–	16.6 (9.22)	17.2 (9.55)	17.8 (9.89)	18.5 (10.30)	–
904L	N08904	–	15.3 (8.50)	15.7 (8.72)	16.1 (8.94)	16.5 (9.17)	16.9 (9.39)
–	S31727	–	15.9 (8.83)	16.4 (9.11)	16.7 (9.28)	17.0 (9.44)	17.2 (9.55)
–	S34565	–	14.5 (8.00)	15.5 (8.60)	16.3 (9.00)	16.8 (9.30)	17.2 (9.50)
–	N08026	–	14.8 (8.22)	14.9 (8.29)	15.3 (8.52)	15.7 (8.73)	16.0 (8.89)
–	S32053	–	14.5 (8.00)	15.0 (8.28)	15.4 (8.55)	15.8 (8.78)	–
–	N08926	–	15.0 (8.33)	15.7 (8.72)	16.1 (8.94)	16.4 (9.11)	16.7 (9.28)
–	S31254	–	16.5 (9.17)	17.0 (9.44)	17.5 (9.72)	18.0 (10.00)	18.0 (10.00)
–	N08367	–	15.3 (8.50)	15.5 (8.60)	15.7 (8.80)	16.0 (8.90)	16.0 (8.90)
–	S31266	–	15.0 (8.33)	15.5 (8.61)	16.0 (8.90)	16.3 (9.06)	16.5 (9.17)
–	N08354	–	14.1 (7.83)	14.6 (8.11)	14.8 (8.22)	15.1 (8.40)	15.4 (8.55)
–	N08935*	–	14.1 (7.81)	14.7 (8.15)	15.1 (8.37)	15.4 (8.56)	15.7 (8.71)
–	S32654	–	15.0 (8.33)	15.4 (8.55)	15.8 (8.78)	16.2 (9.00)	–

Table 6 (continued): Room and elevated temperature physical properties of standard austenitic and HPASS.

Grade	UNS No.	20°C (68°F)	100°C (212°F)	200°C (392°F)	300°C (572°F)	400°C (752°F)	500°C (932°F)
<b>Thermal conductivity - W/m-K (Btu in/hr ft<sup>2</sup> °F)</b>							
304	S30400	14.6 (100)	16.2 (112)	17.0 (117)	19.6 (135)	20.3 (140)	21.4 (148)
316L	S31603	14.0 (97)	14.9 (103)	16.0 (111)	17.3 (120)	18.6 (129)	19.9 (138)
317LMN	S31726	14.0 (97)	14.4 (100)	–	–	–	–
201	S20100	15 (104)	16.2 (112)	–	–	–	21.4 (148)
Alloy 20	N08020	11.6 (81)	13.1 (91)	15.0 (104)	16.6 (115)	18.2 (126)	19.6 (136)
904L	N08904	11.5 (80)	13.1 (91)	15.1 (105)	–	–	–
–	S31727	12.5 (87)	14.1 (98)	16.2 (112)	18.2 (126)	19.9 (138)	21.8 (151)
–	S34565	14.5 (101)	14.5 (101)	–	–	–	–
–	N08026	11.6 (81)	13.1 (91)	15.0 (104)	16.6 (115)	18.2 (126)	19.6(136)
–	S32053	11.6 (81)	12.5 (87)	14.4 (100)	16.1 (112)	17.6 (122)	–
–	N08926	12.0 (83)	12.9 (89)	14.4 (100)	16.5 (114)	18.5 (128)	20.1 (139)
–	S31254	13.4 (92)	14.5 (100)	15.9 (110)	17.3 (119)	18.7 (129)	20.2 (139)
–	N08367	11.5 (80)	13.0 (90)	15.1 (105)	17.2 (120)	19.3 (134)	21.2 (147)
–	S31266	12.0 (83)	–	13.0 (90)	–	14.0 (97)	–
–	N08354	11.3 (78)	13.2 (91)	15.3 (106)	17.6 (122)	19.1 (132)	20.8 (144)
–	N08935	10.1 (70)**	11.8 (82)	13.7 (95)	15.4 (107)	17.2 (119)	18.7 (130)
–	S32654	8.6 (59)	9.8 (68)	11.3 (78)	12.6 (87)	14.5 (100)	–

\* Temperature 30°C (86°F) to T

\*\* Measured at 23°C (73°F)

# 6 Corrosion resistance

Although the standard stainless steel grades provide adequate corrosion resistance for many environments, the HPASS provide the highest corrosion resistance obtainable with stainless steels. While each HPASS has different properties, they all are outstanding in one or more of the three main areas of corrosion performance: general corrosion, pitting and crevice corrosion, and stress corrosion cracking.

The corrosion resistance of all stainless steels depends on a very thin surface layer of chromium oxide, termed the passive film. In order for a stainless steel to resist a specific environment the passive film must provide a stable barrier to the environment and, if the film is scratched or damaged must quickly reform or repassivate. The higher chromium and molybdenum contents of HPASS improve the protective properties of the passive film, making these grades more corrosion resistant. While the passive film protects stainless steel from corrosion, it can break down under adverse environmental conditions. Widespread film breakdown results in corrosion across the entire surface (general corrosion). Localized film breakdown produces very localized types of corrosion such as pitting. Because of their higher content of molybdenum, the film on HPASS is more resistant to breakdown than it is for the standard grades.

The materials engineer should select the most cost-effective grade of stainless steel that will maintain the passive film in the environment of interest. The fabricator and end user must understand the factors that can reduce the alloy's basic corrosion resistance through poor fabrication practices. This section presents some fundamental principles related to stainless steel corrosion resistance. More detailed information on

the corrosion performance of stainless steels in specific environments can be found in the resources cited in the Appendix and data on the corrosion performance of various stainless steels in common environments are given in references (11–13).

## 6.1 General corrosion

General corrosion is a uniform metal loss from the surface that produces a roughly uniform thinning of the cross-section. With stainless steels it most often occurs in strong, warm acids. General corrosion indicates that the environment is too aggressive for the grade selected. If the environment is oxidizing, a grade having more chromium will often give better performance. If the environment is reducing, grades with higher chromium, nickel, molybdenum and copper contents will perform better. Small amounts of contamination from halides or oxidizing species can substantially change the aggressiveness of acidic service environments, affecting their relative oxidizing or reducing powers. Such changes can correspondingly affect the stainless steel's corrosion performance. It should be remembered that no one alloy is best for all environments, and higher alloyed grades are not always better than lower alloyed grades in every environment.

## 6.2 Localized corrosion

### 6.2.1 Pitting and crevice corrosion

Pitting and crevice corrosion occur in a localized area on the surface of a metal. Because there are many ways in which the passive film can be disrupted locally, these forms of localized corrosion are common modes of degradation with stainless steels. Pitting occurs on a relatively clean and bare surface with the area beside the pit often having little

or no corrosion. Crevice corrosion occurs at locations where the stainless steel surface has restricted access to the bulk solution in tight geometries or crevices. Common crevice formers include threaded connections, lap joints, O-ring seals, gasket seals, connectors, rolled tube joints, dirt, oil, grease, crayon markings, tape, strippable film, scale, and corrosion deposits. When a crevice exists, the local environment within the crevice can change compared to the bulk solution chemistry outside of the crevice. This is due to reaction of the solution with the metal surfaces inside the crevice and the effects of mass transport into and out of the crevice. As a consequence, the crevice environment becomes higher in chlorides and lower in pH, resulting in a battery-like effect that drives increased corrosion inside the crevice and reduced corrosion on the metal surface immediately outside the crevice.

Localized corrosion can be a particularly hazardous mode of corrosion, because the rate of propagation can be rapid resulting in through-wall penetration and potential leaks in relatively short time periods.

Resistance to localized attack by pitting and crevice corrosion increases with higher Cr, Mo and N content, which accounts for the large amounts of these alloying additions in HPASS. An empirical relationship called the Pitting Resistance Equivalent number or PREN has been developed to relate a stainless steel's composition to its relative pitting resistance. The PREN relationship for austenitic and duplex stainless steels is usually given as follows:

$$\text{PREN} = \%Cr + 3.3(\%Mo + 0.5\%W) + 16(\%N)$$



The PREN can be useful in selecting the correct stainless steel for chloride-containing environments. If a stainless steel with a certain PREN value fails by pitting or crevice corrosion in a given environment, it is necessary to select a stainless steel with a higher PREN to reduce corrosion. It is not certain how much higher the PREN has to be to avoid corrosion, but it is almost certain that a stainless steel with a lower PREN would also fail. If a certain stainless steel grade works in a given chloride-containing environment, but is not available, selecting a different stainless steel that is both available and has the same or higher PREN is a good strategy to find the most economical alternative.

Although this relationship has been developed to rank pitting resistance, it also provides a relative ranking of a stainless steel's crevice corrosion resistance. The PREN is related to the alloy's resistance under ideal conditions and does not address factors such as the presence of intermetallic phases,

improper heat treatments, inferior surface condition or poor post-fabrication cleaning. Because of this limitation, the PRE number should only be used as an indicator of an alloy's potential performance. PREN should not be used to select a stainless steel when general corrosion is expected to be the most likely corrosion mechanism.

Factors that promote pitting and crevice corrosion include increased levels of halides (especially chloride) and oxidants in the environment, higher temperatures, and more acidic conditions, not aggressive enough to produce general corrosion. Detrimental design or operating conditions include built-in crevices like bolted joints, and deposits related to poor system cleanliness such as scaled surfaces. Careless fabrication practices can also promote localized corrosion by creating roughly ground surfaces where corrosion can initiate. Weld defects such as slag inclusions, undercut, stop/start defects etc. and the presence of heat tint are all areas where pitting is often seen.

Occasionally, poor melt and welding practices can result in certain undesirable nonmetallic inclusions or intermetallic phases that can reduce the resistance to localized corrosion.

Laboratory pitting and crevice corrosion tests in highly corrosive test solutions are used to rank different alloys for their relative corrosion resistance and to assist in the development of improved alloys. Most of these tests use temperature as the ranking criterion for a given set of test conditions. The ranking is expressed in terms of the critical pitting temperature (CPT) or critical crevice temperature (CCT). The critical temperature is the lowest temperature at which corrosion will begin to occur as the temperature is increased (thus a higher critical temperature is better than a lower one). A given alloy's CCT is always lower than its CPT because crevice corrosion initiates more easily than pitting corrosion. **Figure 16** shows critical crevice and pitting temperatures measured in a standard ferric chloride test solution for

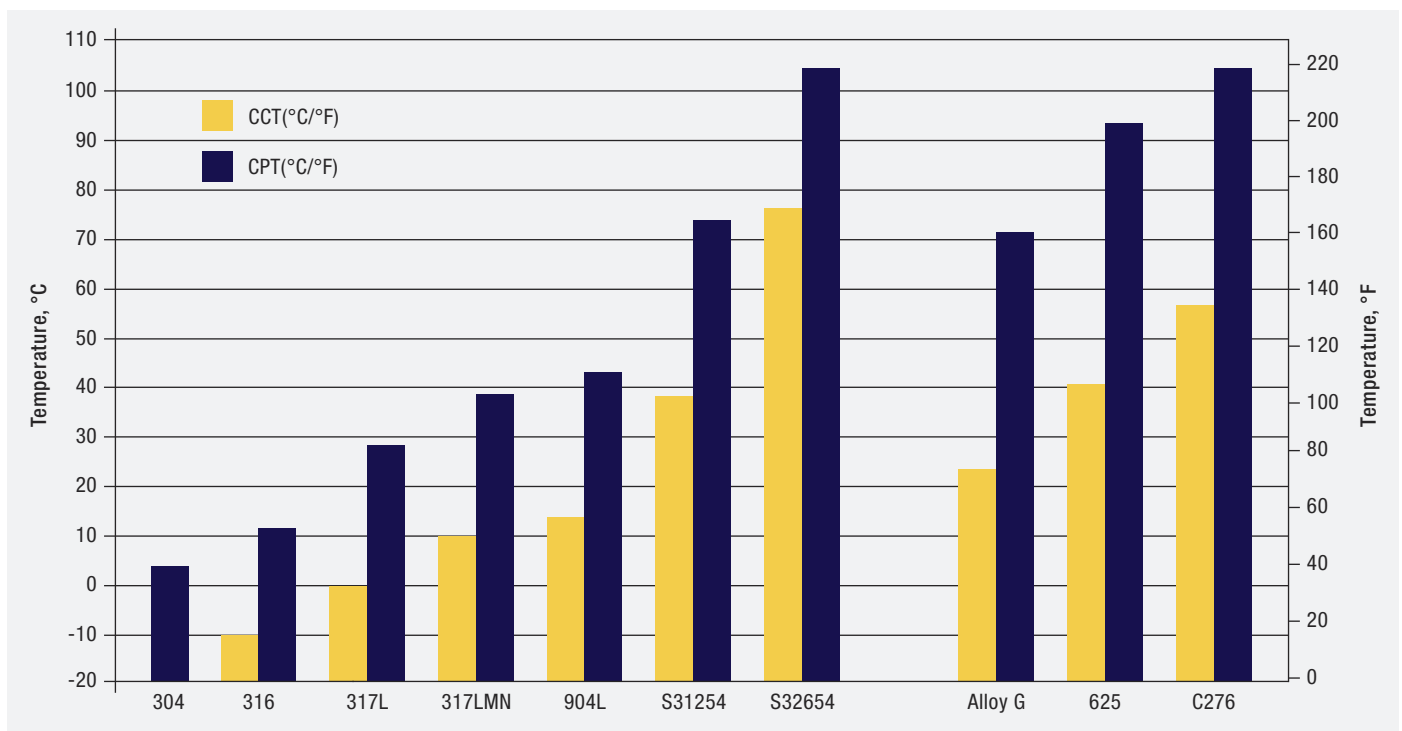

Figure 16: Critical pitting and crevice corrosion temperatures for stainless steels and nickel alloys measured in a 6 weight % ferric chloride test solution. (10)

a number of stainless steels and three nickel alloys. Note the superior performance of HPASS compared to standard Type 316 stainless steel and the significant difference between CCT and CPT for a given alloy.

The ranking tests and resultant critical temperatures do not predict in detail how an alloy will perform in a given environment different from the test solution, but alloys with higher CCT or CPT generally have better corrosion resistance over a range of real environments. Field experience allows some general correlations between the critical temperatures and field performance. For example, Type 316L, with an ASTM G48 CPT of 10°C (50°F), is not suitable for steam condenser tube service in seawater. HPASS alloy S31254, with a CPT of 75°C (167°F), gives satisfactory service in this environment.

### 6.2.2 Effect of secondary phases on localized corrosion

While austenitic stainless steels are composed primarily of austenite phase, they always contain small amounts of other phases that are the normal result of steelmaking, including small amounts of oxide and sulfide inclusions from the steel refining practice in the melt shop and ferrite as discussed in 3.1.1. In addition to these commonly occurring phases that do not have a significant impact on the corrosion resistance, there is the possibility of forming undesirable secondary phases such as chromium carbide, chi, and sigma that can degrade the corrosion resistance (see section 3.3). While it is not necessary, or even possible, for stainless steels to be completely “free of” undesirable secondary phases, their extent must be controlled. Excessive levels of these undesirable phases can facilitate pitting or crevice corrosion, because they destabilize the passive film.

The chi and sigma phases in HPASS can either form in the centerline of plate

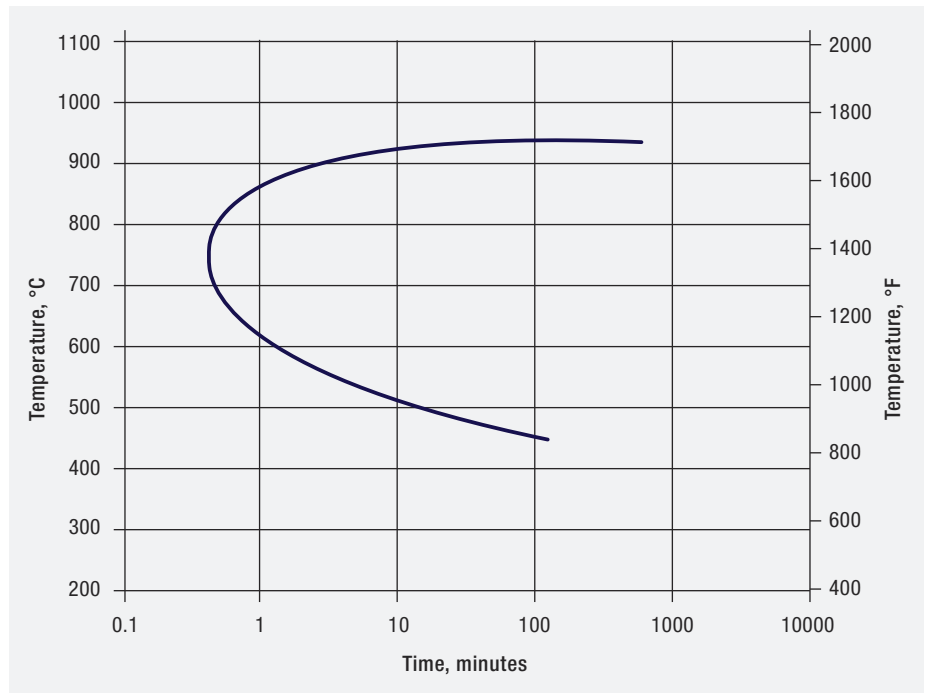

Figure 17: Isothermal precipitation kinetics of the 6% Mo HPASS, S31254. (10)

or sheet product due to alloying element segregation during initial solidification of the steel or they can form at grain boundaries during thermal treatments like annealing or welding as discussed in Section 3.3. Since these phases contain large amounts of chromium and molybdenum, they deplete the surrounding steel in alloying elements and reduce corrosion resistance. If they form in the centerline during steelmaking they usually are not detrimental, because subsequent rolling and annealing processes homogenize the structure and dissolve the intermetallic phases. However, if they form at grain boundaries during shop welding or annealing, they can be very detrimental.

**Figure 17** illustrates the temperatures and times at which precipitation of sigma and chi phase will begin to occur in a 6% Mo HPASS. It shows that at 700°C (1290°F), the time window before the onset of precipitation of undesirable phases, which will degrade pitting resistance, is very short. Thus, annealing

and welding cycles must be controlled carefully and time exposed to these temperatures minimized to avoid secondary phase precipitation that degrades corrosion resistance. If these phases have formed, they can be eliminated by a full solution anneal heat treatment and rapid quench that dissolves them and restores the alloy’s corrosion resistance.

### 6.2.3 Stress corrosion cracking

The combination of tensile stress, a specific environment and a susceptible stainless steel can cause a corrosion mode known as stress corrosion cracking (SCC). SCC failures of austenitic stainless steels most often occur in chloride-containing environments and this mode of attack is termed chloride stress corrosion cracking (CSCC). Although this is the most common type of SCC, other species such as caustic, hydrogen sulfide and polythionic acid can also cause SCC of austenitic stainless steels.

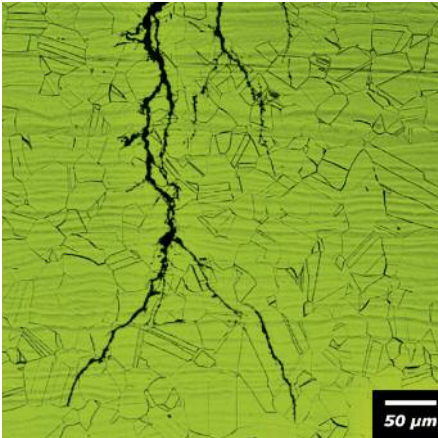

Figure 18: Branching transgranular stress corrosion cracks in a 6% Mo austenitic stainless steel, exposed to high temperatures and chloride levels.

In order for SCC to occur, some form of tensile stress must be present along with the specific corrosive environment. The source of stress can be service stress or residual stress from fabrication processes such as welding or bending. Since residual stresses frequently are quite high, they often are a factor in SCC.

### 6.2.3.1 Chloride stress corrosion cracking (CSCC)

When CSCC occurs in an annealed austenitic stainless steel, it typically exhibits branched transgranular cracks (Figure 18) with a morphology determined by the stress pattern. Sensitization increases SCC susceptibility and promotes intergranular cracking. High stress, high temperature, high chloride content, and low pH all increase the likelihood of stress corrosion cracking. The standard austenitic stainless steels, including Types 304/304L, 316/316L, and the 200 series grades, are very susceptible to this form of corrosion, even at relatively low temperatures and chloride contents. Although the HPASS are much more resistant to CSCC they are not immune and they can suffer CSCC in environments with relatively high temperatures and high chloride contents. Figure 19 presents a summary of case

histories and available CSCC data for Types 304 and 316 in neutral waters. The chloride content required to produce cracking in these alloys at temperatures near boiling or higher can be less than 1 ppm. Under fully immersed conditions in near neutral solutions it is rare to see CSCC at temperatures below 50°C (122°F). However, conditions that concentrate chlorides, such as alternate wet/dry surfaces under insulation or evaporative conditions on stainless steel surfaces can cause CSCC at temperatures well below 50°C (122°F).

Austenitic stainless steels which contain more than the 8–12% nickel present in Types 304 and 316 deliver better CSCC performance. The HPASS, which benefit from their greater chromium and molybdenum contents as well as higher nickel levels, are particularly resistant to CSCC. For example, with the 6% Mo

grades (Figure 19), cracking does not begin until much higher temperature and chloride levels. The temperature thresholds are well above 100°C (212°F), indicating that boiling neutral chloride solutions at atmospheric pressure are unlikely to produce CSCC in the 6% Mo and similar HPASS, a substantial improvement over Types 304 and 316 stainless steels.

### 6.2.3.2 Stress corrosion cracking in other environments

Strong caustic environments produce a type of stress corrosion in stainless steels called caustic cracking. Types 304 and 316, and other similar standard grades, are susceptible at temperatures of approximately 100°C (212°F) or higher. Caustic cracking may be intergranular in nature, or may have a branched transgranular crack morphology, making it often indistinguishable from CSCC.

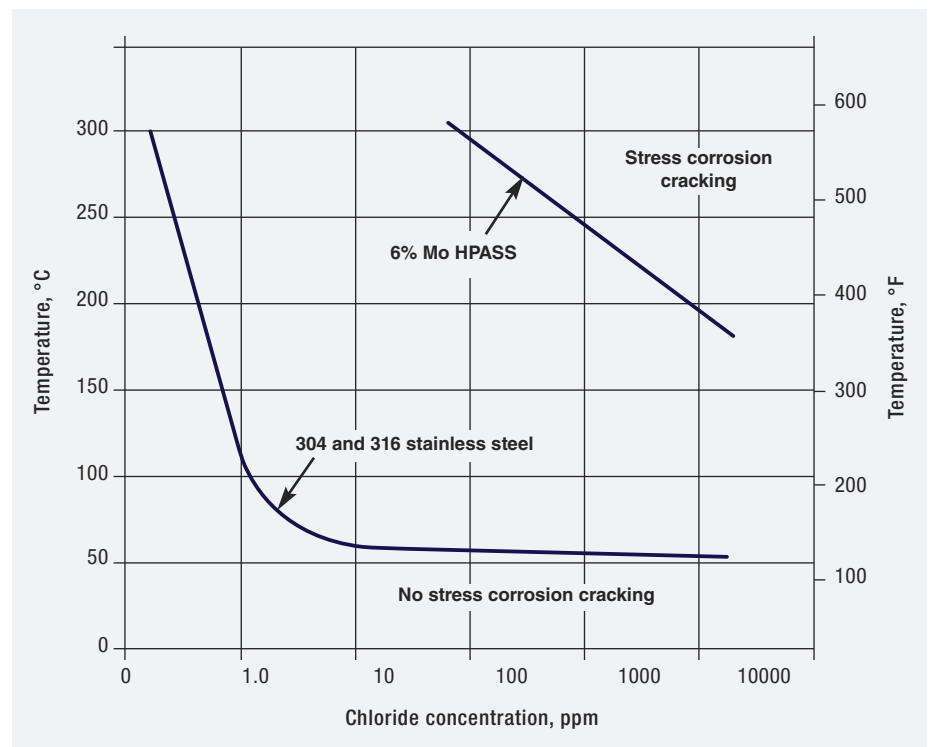

Figure 19: Chloride stress corrosion cracking thresholds in near neutral chloride waters for Types 304 and 316 stainless steels compared to a 6% Mo HPASS.

Increasing the nickel content improves caustic cracking resistance, so all HPASS perform better than the standard grades. However, for applications like caustic evaporators, that operate in very aggressive environments approaching 150°C (300°F), only nickel alloys provide adequate service.

Environments containing relatively high levels of hydrogen can produce a form of cracking termed “hydrogen embrittlement”. Such environments include high-pressure hydrogen gas and strong acids and acid solutions containing species such as cyanides, arsenic, antimony or sulfides which tend to poison the hydrogen recombination reaction and promote the entry of hydrogen ions into the metal. Applications that involve galvanic currents such as electroplating and cathodic protection can also produce hydrogen embrittlement. The cracking that results from ingress of hydrogen into the metal typically has an intergranular crack morphology. All annealed standard austenitic and HPASS grades are highly resistant to hydrogen cracking except for the metastable grades like Type 301 and 201, which can contain martensite. However, any grade that has been heavily cold worked to increase strength and hardness can be vulnerable.

Hydrogen embrittlement in the presence of sulfides is a common problem in oil and gas production environments and this type of SCC is termed sulfide cracking. NACE Standard MR0175 and ISO 15156 provide detailed information on approved grades and acceptable hardness levels to avoid sulfide cracking.

Polythionic acid (H<sub>2</sub>S<sub>4</sub>O<sub>6</sub>) can produce SCC in sensitized austenitic stainless steel, and results in cracking with an intergranular crack morphology. Using solution annealed Types 304L and 316L or sensitization-resistant grades like Types 321 and 347 may avoid this danger. However, even the low carbon grades can become sensitized and

susceptible upon long-term exposure in the sensitizing range. For the stabilized grades, a final stabilization anneal (done at lower temperature than a solution anneal) may be necessary to prevent attack.

### 6.3 Intergranular corrosion/sensitization corrosion

Intergranular corrosion occurs rapidly in or near grain boundaries with little or no attack of the grains. For standard austenitic stainless steels, this mode of corrosion is usually associated with sensitization that occurs during welding or heat treatment (see Section 3.3). Depending on the degree of sensitization and on the corrosivity of the environment, the corrosion can take more than one form. Pitting attack is likely if the sensitization is moderate. If a continuous network of chromium carbides exists along the grain boundaries, corrosion will occur intergranularly and may result in surface grains dropping away. The combination of a sensitized structure, tensile stress, and corrosive environments can produce intergranular SCC. Designers and fabricators have three options to minimize sensitization and consequent intergranular corrosion:

- Employ a low carbon grade (e.g. Types 201L, 304L, 316L, or 317L). HPASS alloys are produced only in a low carbon version. Low carbon content prolongs the time available before chromium carbide precipitation (sensitization) begins during cooling (Figure 8). This makes it possible to do hot forming and welding, even on heavy sections without sensitizing the material. However, the L grades will not resist sensitization during long-term service exposure in the critical sensitization temperature range.
- Use a stabilized austenitic grade such as Types 321 or 347 in which a stabilizing alloying element ties up carbon. The two common additives are titanium (Ti) and niobium (Nb). These

grades require a suitable stabilizing thermal treatment, which preferentially forms titanium or niobium carbide instead of chromium carbide, so that chromium remains in solid solution, providing corrosion protection.

- Solution anneal sensitized material to restore its corrosion resistance. Recommended solution annealing temperatures are in the range of 1040–1175°C (1900–2150°F). The solution annealing treatment followed by rapid quenching must be the last thermal treatment seen by the component. It does not remove the danger of sensitization for components exposed to elevated service temperatures for long periods of time.

HPASS are low carbon alloys that generally contain sufficient nitrogen so that chromium carbide sensitization is typically not a concern. However, as previously discussed, intermetallic phases can form in these alloys under thermal conditions similar to those that produce sensitization in the standard grades. Intermetallic precipitation will result in lower pitting resistance and a loss of toughness.

#### 6.3.1 Weld sensitization/weld decay

During welding, the metal in and near the weld is heated to liquid metal temperatures or just below. The weld metal and heat affected zone are exposed for some time in the sensitization temperature range during heating and cooling. Whether welding sensitizes the steel depends on the alloy, section thickness, and heat input. **Figure 20** schematically illustrates a typical weld thermal cycle and the associated region, which is susceptible to weld decay. The figure shows a band of sensitized material that has formed on either side of the weld. Weld decay is minimized by controlling welding conditions and using one or more of the three previously discussed approaches to avoid sensitization.

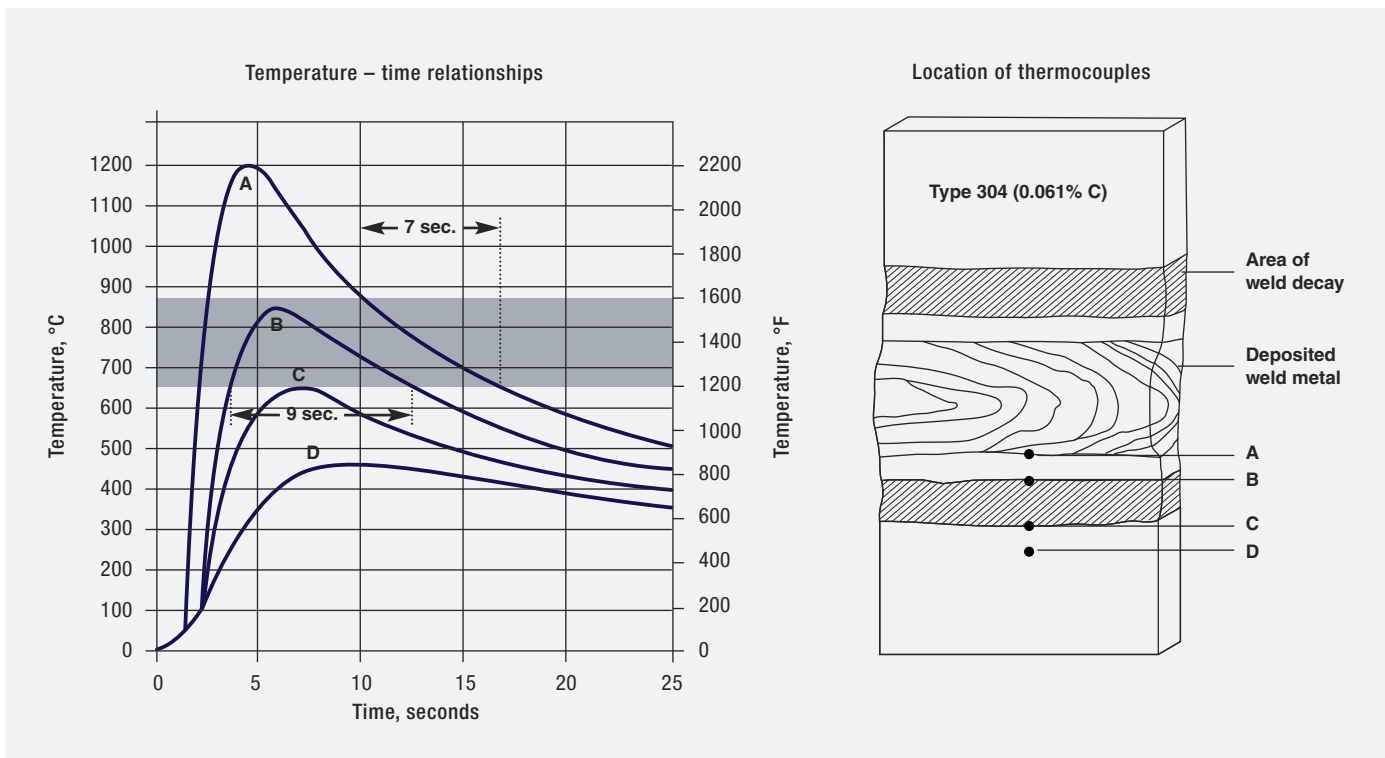

Figure 20: Time-temperature profile during electric arc welding of Type 304 stainless steel and the resulting regions of sensitization and weld decay. The temperature range for fast sensitization is indicated by the gray band in the left drawing. (14)

For the reasons noted in 6.3, HPASS usually do not suffer chromium carbide sensitization during welding. However, weld thermal cycles can promote formation of the intermetallic compounds that can degrade pitting resistance. Welding parameters must minimize the time in the critical temperature range by adjusting heat input and interpass temperature, and multiple weld passes should be minimized (see Chapter 12). Welding with lower heat inputs and lower interpass temperatures results in faster cooling and minimizes the exposure time in the critical temperature range.

### 6.3.2 Knife-line attack

Knife-line attack is a unique form of sensitization that occurs only in the stabilized grades such as Types 321 and 347. If the welding process dissolves Ti or Nb carbides, chromium carbide may form during a subsequent thermal

treatment. This phenomenon produces a very narrow sensitized region adjacent to the weld, hence its name. Most austenitic stainless steels, and HPASS, are not susceptible to knife-line attack because they are not stabilized.

## 6.4 Galvanic corrosion

When a metal is immersed in a corrosive environment it will establish a corrosion potential that relates to the corrosion rate of the metal in the specific environment. Metals that have very low corrosion rates will have more positive or noble corrosion potentials and metals with high corrosion rates will have more negative or active corrosion potentials. **Figure 21** shows a plot of corrosion potentials from active to noble voltages for various metals and alloys measured in seawater. This type of plot is termed a galvanic series and this specific plot is a seawater galvanic series. If two or more different metals or alloys

are immersed in a corrosive environment, are in contact with each other or are electrically connected (coupled) and if the metals have substantially different corrosion potentials in the environment of interest, there is a high probability of galvanic corrosion. When galvanic corrosion occurs the more active metal will corrode at an accelerated rate and the noble metal will tend to be protected and have a reduced corrosion rate, compared to the corrosion rates of each of the metals by themselves in the same environment. For example, if mild steel is coupled to a passive stainless steel, accelerated, i.e. galvanic corrosion of the mild steel is expected because the mild steel is more active and there is large difference in corrosion potentials.

The galvanic series can be used to predict whether coupling dissimilar metals will result in galvanic corrosion. Metals and alloys that are very close to one another

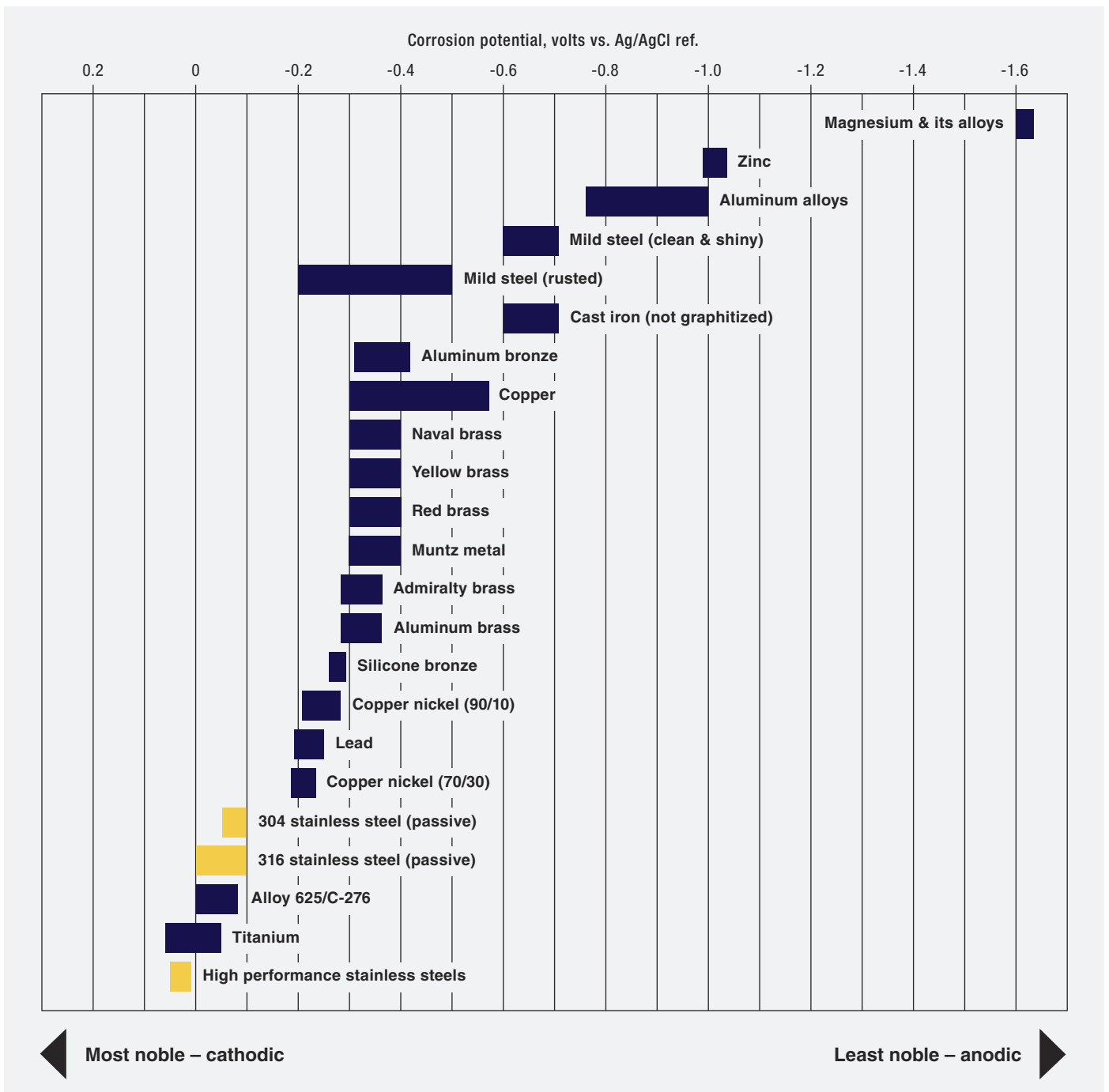

Figure 21: Galvanic series for common metals and alloys, showing the corrosion potentials measured with a Ag/AgCl reference electrode in ambient temperature seawater. Data extracted from (15)

in the galvanic series (small difference in corrosion potential) can be coupled with very little or no risk of galvanic corrosion. By the same token, the farther apart the metals are in the galvanic series, the

more pronounced a galvanic effect with correspondingly higher corrosion rate can be expected on the less noble metal. When using a galvanic series to make predictions, it is important to use a series

that relates to the environment of interest. For example, the seawater galvanic series shown in **Figure 21** would not be suitable for making predictions of galvanic corrosion in acid environments.

Another important parameter for assessing the expected intensity of galvanic corrosion is the relative size of the exposed surface areas of the two metals. With increasing relative surface area of the more noble metal the area for the cathodic reaction increases, which results in a higher rate of metal dissolution or corrosion on the surface of the active metal. Because of this surface area effect, the galvanic corrosion rate increases with increasing ratio of noble metal area to active metal area. A common example of an undesirable surface area ratio is the use of mild steel rivets (small surface area) to join stainless steel sheet or plate (large surface area).

Measures that can be taken to minimize the galvanic corrosion problem include avoiding dissimilar metals in coupled connections, using insulators to electrically separate the dissimilar metals, selecting dissimilar metals that are close together in the galvanic series (Figure 21) and adjusting surface areas of dissimilar metals so that the metal

most likely to corrode has a much larger exposed surface area. If an undesirable dissimilar metal couple is unavoidable, galvanic corrosion can be prevented by coating or painting the noble metal surface in the vicinity of the couple. It is not advisable to coat the active metal surface to prevent galvanic corrosion because any defect in the coating could produce a very undesirable noble metal/active metal surface area ratio and result in accelerated attack at the coating defect.

### 6.5 Relations between fabrication and corrosion resistance

This chapter has dealt primarily with metallurgical and environmental factors affecting corrosion. However, improper fabrication procedures are the cause of many field corrosion problems. Stainless steel depends on a continuous passive film to provide corrosion resistance. Unfortunately, many standard fabrication operations can damage the passive film, degrading the alloys corrosion

resistance. Two broad damage categories can be defined: surface condition and surface contamination. Surface condition includes excessive roughness, residual stress, and chromium depletion. Surface contamination is foreign material deposited on the surface. The list of possible contaminants is long, but some common ones are chloride-containing marking crayons or solvents, iron contamination from tools, and annealing or weld scale. Sections 7 and 14 provide further discussion of these topics and recommendations for fabricators to eliminate or minimize their effects.

Fortunately, corrosion associated with fabrication problems can be avoided by understanding their causes and by taking careful steps to eliminate them. This usually means good housekeeping combined with good post-fabrication cleaning procedures. **Table 7** summarizes typical corrosion problems and the associated fabrication processes which can cause them.

Table 7: Potential influence of fabrication processes on the mode of corrosion (actual effect is dependent on many factors).

Fabrication process	Common stainless steel grades			
	304, 316	304L, 316L	321, 347, 316Ti	HPASS
Hot forming (assuming any heat treatment scale is removed)	IGC	IGC	IGC	IGC, P, CC
Cold forming	SCC	SCC	SCC	SCC
Machining	SCC	SCC	SCC	SCC
Welding				
Thermal effects	IGC		KLA	P, CC
Stress effects	SCC	SCC	SCC	SCC
Heat tint	P, CC	P, CC	P, CC	P, CC
Rough ground surfaces	P, CC	P, CC	P, CC	P, CC
Mechanical joining (bolting, riveting, lock seams)	CC, GC	CC, GC	CC, GC	CC, GC
Surface iron contamination (from various fabrication processes)	P, CC	P, CC	P, CC	P, CC

Note: IGC = intergranular corrosion; P = pitting; CC = crevice corrosion; SCC = stress corrosion cracking; KLA = knife-line-attack; GC = galvanic corrosion

# 7 Care in the shop – keeping the surface smooth and clean

The most important shop rule to follow when working with stainless steel is to keep the surface smooth and clean. Careless handling and fabrication can disrupt the steel's passive film, and may reduce its corrosion resistance. Surface contaminants, especially carbon steel particles and steel scale, and rough or scratched surfaces introduced in the shop, during shipping or on a job site are common causes of problems. Ground stainless steel surfaces with a roughness greater than Ra 0.5 micron (20 micro-inches) typically have reduced pitting corrosion resistance. The loss of corrosion resistance due to rough grinding can

be minimized with an acid passivation treatment.

Fabricators should institute procedures that preserve the steel's surface condition as it moves through the shop. They should cover initial receipt and storage, all handling and fabrication operations, as well as final storage, shipment and pre-installation handling. Procedures should also be in place for maintaining material mill certificate traceability from the initial receipt and storage of raw material to the shipment of fabricated components.

## 7.1 Initial delivery and storage

Fabricators should order stainless steels with protective water-resistant packaging, delivered in enclosed vehicles whenever possible. This is particularly important if transport has the potential of exposing the stainless steel to halide (salt) contamination, which can be encountered during marine transport or when winter shipments are exposed to deicing salts. Steel delivered on open vehicles should be inspected and its wrappings opened to dry if there is any chance that water has penetrated the wrapping. If salts have reached the surface, the wrapping should



Storage of stainless steel coils and cut pieces in a clean distribution center. © Vogel-Bauer



be removed and the surface thoroughly rinsed. Wrapped and packaged stainless steel should be stored indoors in a clean, low humidity environment.

Plate, pipe and other large product forms can be stored outdoors, if necessary, in covered storage areas. They should be free from coastal and deicing salts and airborne contaminants like acid fumes and grinding dust. Racks should be designed and constructed to prevent carbon steel contamination and avoid contact with standing water. Oils, paints, or other shop coatings should not be used to protect stainless steel during storage or fabrication.

Stainless steel should be stored in a clean area, separate from carbon steel storage and removed from any carbon steel fabricating operations. Fabrication of stainless steel and carbon steel in the same shop is particularly prone to iron contamination of stainless steel surfaces due to carbon steel grinding dust. This is extremely important, because a stainless steel surface that has been contaminated with carbon steel particles, also called free-iron, can easily develop a rusted appearance, which can lead to pitting corrosion in service.

Cut sheet product should be stored horizontally in wooden boxes to maintain flatness and prevent edge damage. It should be interleaved with paper or plastic to maintain the surface quality and finish. Cardboard and other materials that might transfer a pattern to the surface should be avoided on highly polished surfaces. Boxes should be covered to prevent airborne contamination. Thicker plate product should be stored vertically to near-vertically on racks in a covered dry location, to minimize airborne contamination and to avoid footprints contaminating plate surfaces.

Stainless steel must also not be stored in contact with, or in the same area, as galvanized steel or copper. Surface contamination by copper, zinc, or other low-melting metals can embrittle stainless

steel during welding or heat treatment (liquid metal embrittlement).

## 7.2 Strippable protective films

Stainless steel flat products can be ordered with a protective plastic strippable film, specifically designed to protect surfaces during laser cutting, bending, roll forming, stamping and other fabrication operations as well as during transport to the job site. Films designed for use throughout fabrication can help reduce or prevent scratches, nicks, and surface contamination from metal particles. They are particularly useful when the surface appearance or quality is critical, such as in architectural components, appliances and food contact surfaces. These strippable films remain in place during short-term storage and fabrication.

The films used for fabrication are typically not intended for UV (ultraviolet) exposure, e.g. exposure to the sun, and it may be necessary to remove and replace the fabrication films prior to post-fabrication transit and installation, if UV exposure is unavoidable. Even a short period of UV exposure can lead to adhesive deterioration, if the film is not intended for that purpose. This causes the film to become brittle and nearly impossible to remove from the metal surface without leaving traces. Also, UV rated films are typically better at withstanding the extreme temperature variations that can occur in storage. UV rated films are intended to protect the surface of the stainless steel when components will be exposed to the sun, even for a short time, as could occur on a construction site.

All protective films have a limited service life, based on the date of production and exposure conditions. This includes the maximum storage temperature and other factors that can limit service life. Film service life maybe as little as 3 or as long as 9 months, depending on exposure conditions. The film life should be tracked and the film should be



Strippable film protects the stainless steel surface finish from scratching and dirt during fabrication and transport. © IMO A

removed from the surface prior to the expiration date. Purchasers of products protected by strippable films should request information on the service life and limitations like storage temperature and UV exposure.

If improperly handled, residual adhesive can remain on the surface after the film has been removed. This trace adhesive can be difficult to remove. There are many types of adhesives and before attempting to remove residual adhesive it is best to obtain the guidance of the film producer. Some can be removed with household detergent and water solutions while others require commercial adhesive removers. Residual adhesive should be removed as quickly as possible.

Film-protected stainless steel should also be stored under temperature controlled low humidity conditions. All films are moisture permeable and rain, fog and humidity can pass through them as well as dissolved salts and other contaminants. This can lead to crevice corrosion, especially if any chlorides are present for example in coastal locations or where road salts are used. For that reason, stainless steel that will be installed at an exterior location, that has a potential of chloride contamination, should be stored off-site until installation and the film should be removed as the panels are put in place.

### 7.3 Avoiding iron contamination

Contact with carbon steel should be avoided during all fabrication and handling. Transport clamps, straps, chains, hooks, and other devices should either be made of stainless steel or be protected with plastic or cardboard to prevent carbon steel contamination. Special tool sets should be dedicated for use on stainless steel only. Color-coding tools to differentiate those used on carbon steel from those used on stainless steel is helpful.

Only clean grinding wheels, sanding belts, and blast media (glass or ceramic beads, silicon carbide or stainless steel shot), free of iron contamination, should be used on stainless steel. Once any of these media have been used on carbon steel they cannot be used on stainless steel. Contaminated media will transfer iron particles to the stainless steel surface and particles can get embedded into the material, both of which will produce surface rust. Steel shot must not be used on stainless steel. For the same reason, only stainless steel wire brushes and stainless steel wool should be used for cleanup. They must not have been used previously on carbon steel.

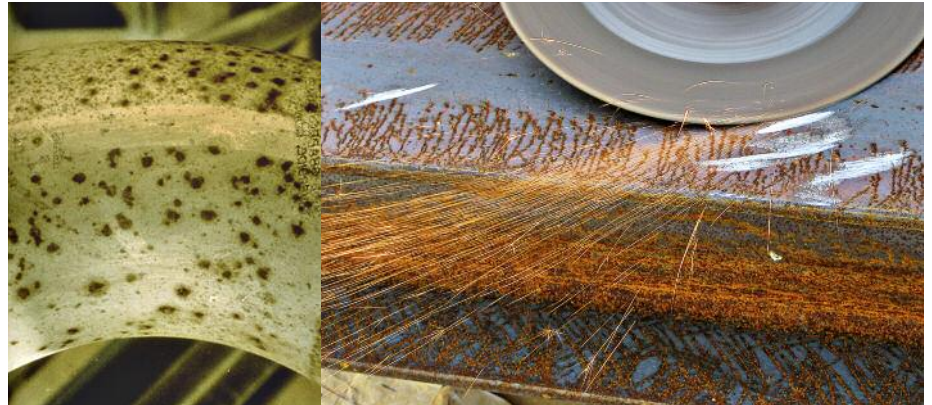

The surface of the stainless steel elbow on the left has been contaminated with carbon steel particles. A possible cause is grinding of carbon steel in the immediate vicinity and carbon steel sparks depositing on the stainless steel surface.

Rolls, presses, and dies used for stainless steel fabrication should be cleaned thoroughly to remove steel particles or scale if they have been used to process carbon steel. Protective paper or plastic film can prevent contamination by carbon steel particles from the forming tools.

If a stainless steel is contaminated with carbon steel, the contamination should be removed and the surface restored by an

acid passivation procedure (see section 15.1.1). If a large amount of carbon steel has been embedded into the surface of a stainless steel, the remediation may require a more aggressive acid pickling procedure (see section 15.2.6) to remove all iron contamination in a timely manner. However, avoiding carbon steel contamination altogether is the most cost effective solution.

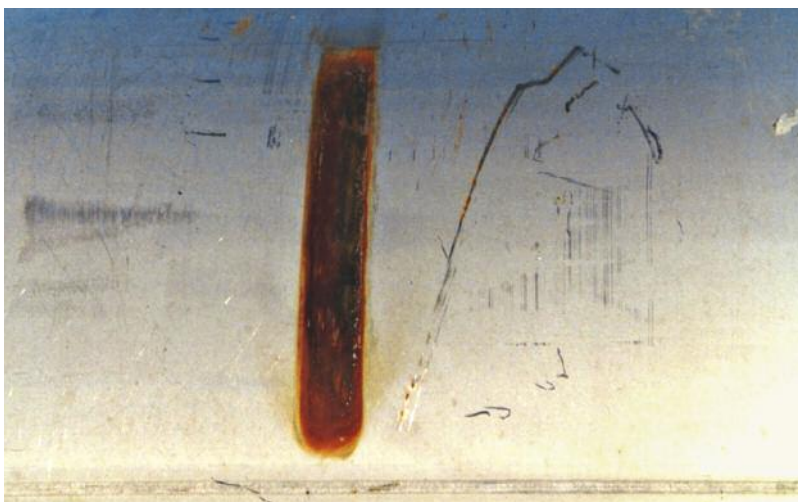

Carbon steel strapping has produced rust marks on a stainless steel pipe.

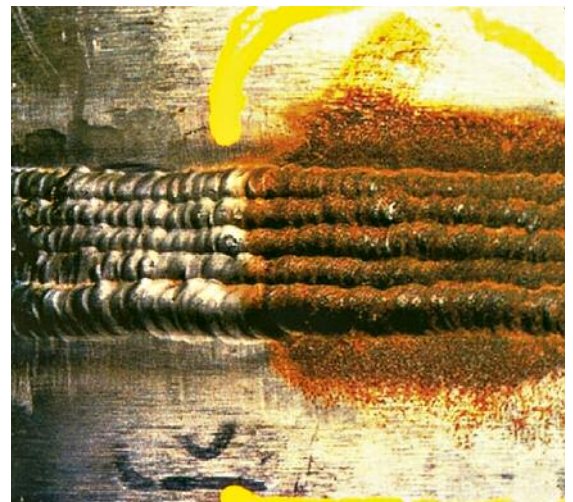

Carbon steel wire brushes used to “clean” stainless steel welds can produce discoloration and rust. Stainless steel wire brushes must be used. © Outokumpu Stainless

# 8 Hot and cold forming

## 8.1 Hot forming

Austenitic stainless steels have excellent forming characteristics in hot rolling, forging, and extrusion operations. Standard austenitic grades have higher hot strength than carbon steels, and HPASS have much higher hot strength than the standard grades. Thus, reductions per pass will be less than those for carbon steels and may be limited by equipment capability, especially with HPASS. It is important that stainless steels be heated throughout when being hot worked. This means longer reheating times than for carbon steel because of their lower thermal conductivity. However, the high molybdenum grades (HPASS) can scale rapidly; therefore, the operator has to minimize holding times during pre-heating.

Because austenitic stainless steels undergo a rapid loss in ductility at very high temperatures, the upper temperature limit for hot working is kept well below

the melting temperature. Delta ferrite transformation causes this ductility loss in standard austenitic grades. With HPASS, the loss is related to low-melting sulfide or phosphide phases in the microstructure. Hot working at very high temperatures should also be avoided to minimize heavy scale formation during the forming operation. The lower temperature limit is kept where the steel can still dynamically recrystallize and soften during hot forming, i.e. above the temperature where it work hardens rapidly. Because of the potential loss of toughness, particularly in HPASS, the lower temperature limit should be above the temperature where undesirable phases such as sigma form.

**Table 8** gives hot forming temperature ranges for various austenitic stainless steel categories. All grades have an upper temperature limit around 1175–1200°C (2150–2200°F), but the lower limit depends strongly on the grade. It is quite low for the standard grades, and is

considerably higher for the more highly alloyed steels, a consequence of their high strength and propensity to form intermetallic phases. This grade dependence of the lower temperature limit means that the size of the processing window for hot working decreases with increasing alloy content, with HPASS having the smallest window in which to work.

It is important to maintain uniform workpiece temperature during hot forming, avoiding lower temperature regions of the workpiece (e.g., visibly darker edges than the bulk of the workpiece or even black relative to a red-hot surface). Cooler regions may drop below the minimum forming temperature and tear or crack because they have insufficient ductility to withstand further deformation.

The workpiece should be solution annealed and water quenched after hot forming to ensure a uniform microstructure, virtually free of sensitization, detrimental second phases, and

Table 8: Hot forming ranges and solution annealing temperatures for austenitic stainless steels.

Grades	Hot forming temperature range		Solution annealing temperature <sup>1</sup>	
	°C	°F	°C	°F
Standard grades 201, 304, 316, 321	870–1200	1600–2200	1040 min.	1900 min.
High temperature grades 309, 310	980–1175	1800–2150	1050 min.	1925 min.
6% Mo-0.2% N grades S31254, S31266, N08367, N08926	980–1150	1800–2100	1150 min.	2100 min.
	900–1200	1650–2190	1150 min.	2100 min.
	1000–1260	1830–2300	1105 min.	2025 min.
	900–1200	1650–2190	1100 min.	2010 min.
7% Mo-0.5% N S32654	1100–1200	2000–2200	1150 min.	2100 min.

<sup>1</sup> Solution annealing temperatures are based on ASTM A480/A480M requirements. Temperatures higher than the minimum may be necessary to remove secondary phases in a reasonable time on some alloys.



Hot pressing of petals for a vessel head.  
© Antonius Vesselheads BV

excessive residual stresses. A fully solution annealed structure decreases the risk of sensitization during later welding of standard grades; and increases the time available for welding before chi and sigma phases precipitate in HPASS. A solution anneal also minimizes residual stresses that can lead to dimensional instability in subsequent fabrication processes and service.

If the temperature of the workpiece never falls below the minimum solution annealing temperature, the hot forming process may be considered a “process anneal”, where the temperature exposure during hot forming followed by rapid cooling is used as a substitute for a separate solution annealing cycle. However, when using a process anneal the temperature control is critical to ensure that a proper solution anneal temperature is maintained throughout the entire workpiece.

Austenitic stainless steels require rapid cooling after hot working to avoid the precipitation of carbides or detrimental secondary phases. The appropriate cooling medium depends on section thickness and composition, mostly the carbon content in standard grades and the molybdenum content in the more highly alloyed grades. Unstabilized grades with greater than 0.030% C should be water quenched to prevent sensitization. Standard grades with less than 0.030% C, or stabilized grades like Types 321, 347, or 316Ti, can be air-cooled. Grades

with more than 3% Mo should be water quenched to prevent formation of intermetallic phases. Increasing section size increases the required cooling capacity to provide sufficiently rapid cooling in the center section, to avoid secondary phases.

## 8.2 Warm forming

Heavy section austenitic stainless steel plate is often warm formed to take advantage of reduced strength at elevated temperature. Unlike the ferritic and duplex grades, the austenitic grades do not form secondary phases at temperatures up to about 480°C (900°F). This defines an upper limit for warm forming of austenitic grades. The limit may be higher for low-carbon or stabilized grades or for material that is solution annealed and quenched after warm forming.

## 8.3 Cold forming

Austenitic stainless steels have very high ductility at ambient temperatures, which translates into excellent formability in cold-forming processes, ranging from simple bending to complex deep drawing and stretch drawing. Differences among grades are due to differences

in strength and work hardening behavior. High strength grades like HPASS and the 200 series stainless steels require greater press power or pose limitations on the section size. High work hardening grades, such as Types 301 and 201 are particularly suitable for stretch-type operations.

When a metal is cold formed there is a tendency of the part to partially return to its original shape after the forming tool is removed (**Figure 22**). This tendency is termed “springback” and cold forming

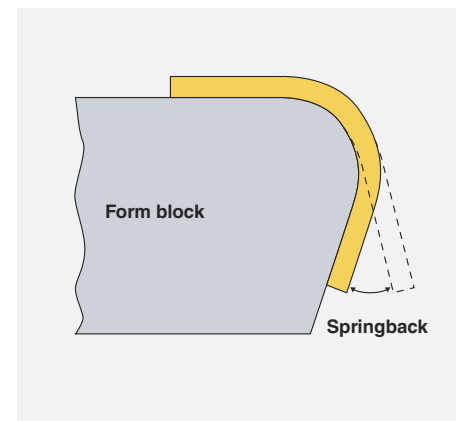

Figure 22: Forming or bending of metal over a forming block results in some springback. This has to be taken into account when planning forming operations to ensure the correct final dimensions. (16)



Intermodal tank containers are typically made of Type 316 stainless steel. They are cold formed into their cylindrical shape. © IMO A

operations must compensate for it in order to achieve the desired final shape (see section 8.3.1 for specific details on springback associated with bending operations). The amount of springback will increase with increased strength and work hardening rate of the steel. Standard grades with low austenite stability, such as Type 301, and nitrogen alloyed grades, such as most of the HPASS, have increased yield strength and higher work hardening rates which result in a larger amount of springback. The 200 series grades that have both low austenite stability and higher nitrogen contents tend to have the largest amount of springback. Nitrogen variations within specified composition ranges can result in significant variations in formability and expected springback, even in the standard grades having 0.10% N maximum.

### 8.3.1 Bending

Austenitic stainless steels in the annealed condition can be formed to tight bends. For example, using a free bend, where the ends of the sample are pushed together without any force applied to the bend itself, a 180° bend over a radius of half the material thickness (1/2 t 180° bend), independent of the rolling direction, is a common acceptance criterion for standard austenitic grades. However, as shown in **Table 9** this criterion has to be relaxed for higher strength or temper rolled material.

During bending operations springback can be compensated by using a larger bending angle to “over bend” the metal so that the desired final angle is obtained when the bending force is removed. The amount of springback depends on geometric factors and the characteristics of the stainless steel. Geometric factors that affect the amount of springback include wall thickness of the part and the bend radius. The amount of springback increases with an increasing ratio of bend radius to section thickness and with increasing yield strength and work hardening rate of the steel.

**Table 9: Typical minimum bend radii for 180° free bends.**

Steel type and work hardened condition	Bend radius
Annealed standard austenitic stainless steels	0.5 t*
HPASS	1.0 t*
Work hardened standard austenitic stainless steels	
¼ hard	0.5–1.0 t*
½ hard	1.0 t*
Full hard	3.0 t*

\* t = metal thickness

**Figure 23** shows the relationship between die radius, material thickness and part angle for an annealed 300 series stainless steel. As an example, parts with a die radius/thickness ratio of 10 will on average have a die angle/part angle ratio of 1.12. With this example if a part is to have a final bend angle of 90° the part must be bent to 100.8° which corresponds to a springback of 10.8°.

For grades with different strength characteristics the amount of springback is normally proportional to (17):

$$[0.2YS + UTS]/2$$

where YS and UTS are yield strength and ultimate tensile strength, respectively.

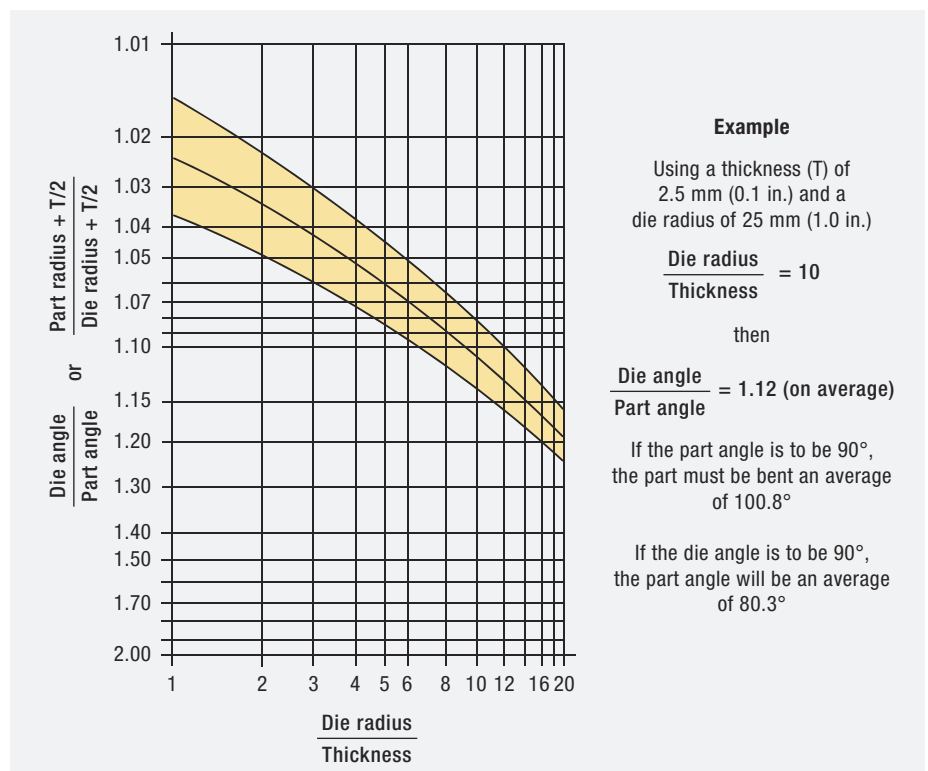

**Figure 23: Relationship between die angle/material thickness, part radius, and part angle for bending an annealed 300 series austenitic stainless steel. (16)**

This relationship can be used to compare springback of stainless steels with different strength levels. Assuming that the 300 series stainless steel shown in Figure 23 has a yield and tensile strength of 275 MPa (40 ksi) and 655 MPa (95 ksi), respectively and using the expected 300 series springback of 10.8° the above expression can be used to approximate the springback for a higher strength stainless steel. For example, a HPASS with a yield strength and tensile strength of 345 MPa (50 ksi) and 790 MPa (115 ksi), respectively the springback can be calculated as follows:

$$\frac{A}{B} = \frac{10.8^\circ}{x}$$

Where:

$$A = [0.2(275) + 655]/2 = 355$$

$$B = [0.2(345) + 790]/2 = 429.5$$

$$\frac{355}{429.5} = \frac{10.8^\circ}{x}$$

$$x = 13.1^\circ$$

Based on this approximation, if a HPASS were used in the example given in

Table 10: Minimum bend radii for press brake forming. (16)

Steel type and work hardened condition	Bend radius
Annealed standard austenitic stainless steels	0.5–1.5 t*
Work hardened stainless steels	
¼ hard	1–2 t*
½ hard	2.5–4 t**
Full hard	4–6 t*

\* t = metal thickness

Figure 23, the material must be bent to approximately 103.1° to achieve a final bend angle of 90°.

### 8.3.1.1 Press brake bending

A press brake is a machine tool for bending sheet metal to an exact shape by clamping the sheet between a punch and die. The dimensions of the punch and die are chosen to accommodate springback and produce a final shape with the desired bend angle after the bending force is removed. Press brake bending of austenitic stainless steels is performed

the same way as the bending of carbon steels, with allowances for the higher strength and greater springback of stainless steel. Minimum bend radii for press brake forming of standard annealed and work hardened stainless steels are given in Table 10.

### 8.3.1.2 Roll bending

Roll bending is a common practice in the fabrication of vessels, tanks, and other hollow round sections. The bending of sheet and plate is often performed using a three-roll forming machine. With this equipment the top roll is fixed while the bottom roll adjusts vertically to compensate for material thickness. The third roll is adjusted angularly to set the diameter of the bend.

### 8.3.2 Roll forming

Roll forming is a highly efficient and economical method to produce long open shapes like angles and channels. It is also used as a means of stiffening panels by imposing character lines like ridges or grooves, reducing the required thickness in architectural or transportation applications. Austenitic steels are readily roll formed, but their wide variations in strength and work hardening rate, as a function of the grade and specific composition, introduce variability in the dimensional tolerances of the roll formed product. Steelmakers can minimize variability by restricting the variation of nickel, carbon, and nitrogen content for a given stainless steel.



Press brake bending of stainless steel sheet. © IMOA



Three roll bending machine. © IMOA



Formed stainless steel channel exiting a roll forming machine.  
© Warut Sintapanon/Dreamstime.com

### 8.3.3 Drawing and stretching

Cold forming operations, that involve the drawing of material into drawing dies to produce the desired shape, range between two extremes:

**Pure drawing operation:** the edges of the metal are not restrained, and the metal is allowed to be drawn into the die. Material for drawing operations should have enough ductility to flow into a die with minimal edge clamping and

should not work harden too much in the process. Stainless steels specifically designed for deep drawing operations such as Type 305 have high ductility and a very stable austenite phase and in turn a low work hardening rate.

**Pure stretching operation:** the edges of the metal are clamped in place so the drawing is achieved solely by stretching the metal into the die. This operation is accompanied by a corresponding reduction in wall thickness of the part. Material for stretching operations should have a high work hardening rate such as Type 301, which allows for a greater formed depth without fracture.

Certain grades have compositions balanced to encourage work hardening through deformation induced martensite formation, which augments stretching. For example, Type 301 with its higher carbon and lower nickel content has a very high work hardening rate that strengthens areas thinned by forming.



A complex sink that requires drawing and stretching can be made from austenitic stainless steel.  
© Outokumpu



Intricate pattern of cold formed heat exchanger plates. © Graham Sussex



Spin forming of an austenitic stainless steel tank head takes advantage of the steel's high ductility. © IMOA

This shifts strain to adjacent softer areas so that deformation can continue without fracture. The picture above shows a heat exchanger plate, which is fabricated using a stretch-forming operation requiring a large stretch capability. The length of the profile after forming is far greater than the starting length of the sheet. The excellent work hardening behavior of the austenitic grade enables the steel to form the channels without fracturing at the bends.

Most practical forming operations use a combination of drawing and stretching. The properties of the blank therefore need to match the degree of draw or stretch involved with the given part design. Since there are many stainless steels available with a range of mechanical properties, it is often possible to optimize material selection for a particular operation. However, the sophisticated technology of sheet forming has also spawned specialized steel compositions within the standard chemical composition ranges to meet specific needs of a forming operation.

### 8.3.4 Spin forming

Spin forming is a cold forming process that involves the rapid rotation of a metal disc or tube while a round-nose tool or a spinning roll applies pressure to form an axially symmetric part. Spin forming requires high ductility and low work hardening rates, so the high work hardening rates of some standard austenitic grades limit their use in this process. Compositional modifications can solve this problem. Types 305, 309, 310 and 904L have a high nickel content (and sometimes small copper additions), which reduces the effective work hardening rate, producing alloys that are more easily deep drawn and spin formed. Even with their high ductility, due to the large deformations involved in this process, these steels may require intermediate annealing steps to avoid cracking and achieve the desired final shape.

### 8.3.5 Cold heading

Stainless steel bolts and other fasteners are easily manufactured by cold heading

(axial stamping within a die). Some work hardening is desirable to increase the strength of the bolt head, but high ductility and low work hardening rates make the process easier to accomplish and reduce tool wear. Types 304 with increased contents of nickel (Type 305) or copper (S30433, sometimes called as "302HQ") provide excellent flow characteristics, minimizing the risk of edge cracking. **Figure 24** illustrates a cold heading process.

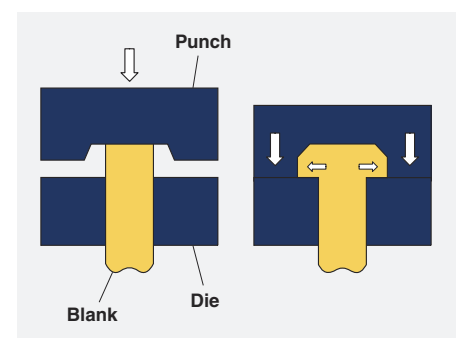

Figure 24: Cold heading of a stainless bolt requires good metal flow within a die.



# 9 Cutting

Austenitic stainless steels are readily sawed, sheared, punched, and cut by water jet, plasma or laser techniques. These methods can cut plate and other large components with dimensional precision and surface quality that sometimes meet final requirements. The same methods used for standard austenitic grades can also cut HPASS. Stainless steels should not be cut with an oxyacetylene torch.

## 9.1 Saw cutting

Cutting stainless steel with band saws and hacksaws requires a sharp, quality high-speed steel saw blade, positive feed rate, and good alignment. A strong coolant/lubricant flow should be directed at the point of cutting. Synthetic emulsions are ideal for this purpose.

Positive feed and minimal blade “wander” are important factors in cutting austenitic stainless steels because of their high work hardening rates. The saw needs sufficient power to drive the feed of the blade to cut beneath the previously

work hardened cut layer. If the blade smears the surface instead of cutting it, the surface will be hardened and resist further cutting, leading to rapid blade wear and loss of cutting ability.

### 9.1.1 Power hacksawing

The hacksawing of austenitic stainless steels requires adequate cooling which is accomplished by flooding the cut area with cutting fluid. There should be more than one tooth in contact with the workpiece at all times which necessitates the use of smaller pitch blades for thinner material or smaller diameters (Table 11). As the material thickness or the diameter increases tooth spacing should increase for better clearance and to minimize chip packing (18).

The higher strength grades, both those with nitrogen additions and those with molybdenum and nitrogen additions, may require very high-power machines because of their combination of high strength and high work hardening rate. If

Table 11: Recommended hacksaw blade pitch. (18)

Workpiece-thickness/diameter	Number of teeth per 25 mm
< 6 mm	10
6–10 mm	10–8
10–25 mm	4–6

the saw cannot maintain positive feed, another cutting method may be required.

### 9.1.2 Band sawing

Low speed band sawing is very similar to hacksawing and the blade pitch and cutting fluid recommendations given in Section 9.1.1 also apply to this sawing method. High speed band sawing involves frictional heating immediately ahead of the blade, which results in the softening of the metal which makes cutting easier. The relatively low heat conductivity of austenitic stainless steels favors the retention of heat immediately in front of the blade making this cutting method ideal for austenitic stainless steels. Because this method does involve heating there is the potential of degrading corrosion resistance of the cut edges.

## 9.2 Abrasive disc cutting

Using bonded, abrasive cut-off wheels, rotating at high speeds, is a common method of cutting small section sizes and for straight-line cutting of sheet and thin plate material. Aluminum oxide discs are typically used for abrasive wheel cutting of stainless steels. The cutting can be performed either dry or wet using a soluble oil emulsion. With abrasive cutting care must be taken to avoid overheating the cut edge.



Typical bandsaw used for cutting of stainless steel.

### 9.3 Shearing

Straight-line shearing is a fast, accurate, and highly effective method of making straight cuts in metals and alloys. The high ductility and work hardening rate of austenitic stainless steels cause them to require machines that are more powerful than those used for common lower-strength carbon steel. For example, a shear rated for 6.35 mm (0.25 inch) thick carbon steel may be limited to 4.75 mm (0.187 inch) when shearing type 304 stainless steel (19). Modern high strength shears typically provide excellent shape and dimensional accuracy for standard austenitic stainless steel plate of up to 25 mm (1 inch) thickness. In order to shear the higher strength HPASS alloys, the thickness rating of the shear must be reduced in proportion to their increased strength relative to Type 304.

#### 9.3.1 Equipment requirements

The shearing of austenitic stainless steels requires more rigid machines, sharp blades, and careful setup. Blades should be made from high quality tool steel quenched and tempered to yield the correct combination of strength and toughness. They should be kept free of

shop dirt and inspected frequently to avoid build-up of metal due to seizing. The recommended blade clearance for austenitic stainless steels is smaller than that used for carbon steel. For straight line cuts, clearance is usually about 5% of the material's thickness. To counteract the greater shearing force required for austenitic stainless steels the hold down pressure on the clamps might have to be increased. Lubrication is generally not needed for straight-line shearing, but strippable films may be used to protect surfaces.

The rake/shear angle (Figure 25) impacts the power requirements of the shear. Smaller angles require higher power/force but do result in less distortion. The smallest angle that should be used is  $1/2^\circ$ . Larger rake/shear angles (e.g.  $3.5^\circ$ ) reduce the required power/force but tend to increase distortion. Larger angles also require a higher hold down pressure on the clamps (16).

#### 9.3.2 Sheared edges

Sheared edges have distinct areas or zones, which include a zone of rolled over metal just below the top surface of the cut, a burnished or sheared zone,

a fractured zone and a burr at the bottom surface of the cut (Figure 25). The depth of the burnished and fractured zones varies depending on the alloy, metal thickness, shear clearance, lubrication, and tool coatings. The ideal depth of the burnished area differs with the metal and type of cut.

It is critical for a fabricator to understand that the shearing clearances, ideal punch speeds and ideal burnish depths vary with the metal and tooling adjustments must be made. The ideal set ups for low-carbon steel, stainless steel, aluminum and brass are different and there are differences between stainless steel alloy families and sometimes within them. For example, at a certain clearance, the burnish depth may be 50% for low-carbon steel, 30% for stainless steel, and 60% for aluminum. The clearance would have to be reduced for stainless steel if the goal is a 50% burnished area.

A tight clearance can produce an entirely or almost entirely burnished edge creating a smoother finish, but can reduce tool life. Excessive clearance causes strain hardening, places unnecessary demands on equipment and can cause larger rough-edge burrs with micro-cracks.

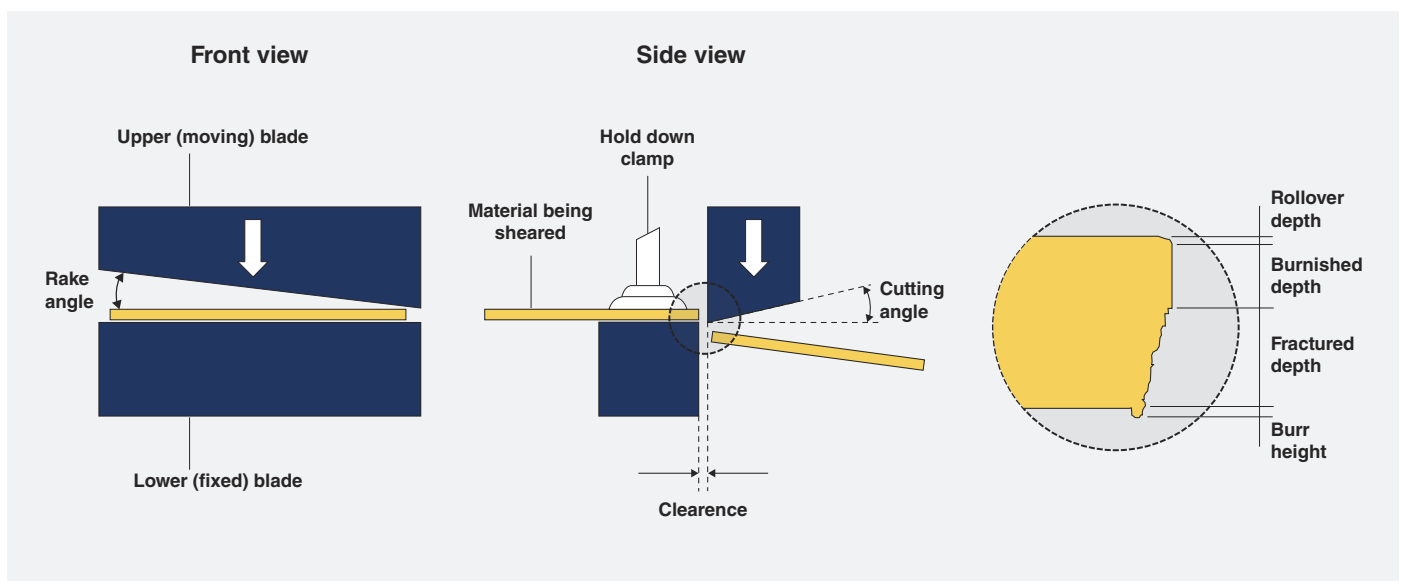

Figure 25: Shearing parameters (16) and detail of sheared cross section, showing distinct zones on the cut edge.



Shearing a stainless steel sheet. © IMO A

Sheared edges have a substantial amount of cold work with increased hardness and burrs can contain torn edges and microcracks. Because of this, forming operations after shearing can be susceptible to cracking. This problem can be corrected by grinding, filing, mechanical polishing or electropolishing of the cut edge to remove burrs and the work hardened surface layer.

At the interface between the burnished and fractured zones, there can be areas of smeared overlapping metal if the tooling is dull or is not kept clean, which can be susceptible to crevice corrosion. Clean, smooth burnished and fractured areas provide the best corrosion performance. Any rough area is more prone to corrosion because it retains moisture longer and accumulates corrosive deposits. When there are high aesthetic, corrosion performance or cleanability requirements, electropolishing of the panels is a common means of removing burrs and overlapped areas on the fracture interface.

### 9.3.3 Blanking and piercing

Blanking and piercing are forms of shearing that use a punch and die to shear the material instead of straight-edged shear blades. Blanking is used to

cut-out a desired workpiece with the remaining sheet being scrapped and piercing, which is similar to blanking, is used to perforate a workpiece with the cut-out piece being scrapped. For blanking and piercing operations, it is often helpful to use lubrication or a strippable film developed for this purpose. When the cut-out blanks are required to be flat, a punch is used and the shear is incorporated into the die. For piercing operation where the cut out

piece is scrapped the shear should be on the punch and the die left flat.

For holes and curved patterns, clearances are about 10% of the overall thickness for press blanking, or 5% on a side. Tolerances can vary with the specific shop equipment, accuracy requirements and other variables.

Smeared, overlapping metal on the sheared edges of pierced holes can be reduced or prevented by using sharp cutting blades and a tight blade clearance. The guidelines for the percentage of open (i.e. perforated) area, that can typically be created by perforation, varies with the hole pattern (hexagonal, round or square holes, slots, etc.). The holes can be aligned or staggered. For stainless steel, the hole diameter should exceed the sheet thickness by at least one gage size to avoid tool failure. Holes and curved areas will have a larger fracture surface.

Several additional considerations are important to minimize distortion when piercing or blanking. The characteristics of an individual austenitic alloy and its level of cold work can affect the pattern and procedure. The minimum distance



Piercing operation to produce a perforated stainless steel sheet.

between holes should be at least half the hole diameter. If lighter gauge panels from annealed material are used, the hole spacing may have to be larger. Distortion can often be reduced by adjusting the setup or tool design or by using metal that has been cold rolled to a slightly higher strength by the mill.

For holes and curved shapes, it is often helpful to use a lubricant or a strippable film developed for this purpose, since it reduces the power requirements and improves tool life. When lubricants are used, the fabricator should also have a cleaning line to fully remove them from the surface before shipment.

### 9.3.3.1 Perforating

Piercing is the most common and cost-effective means of perforating standardized round, oval and other similar uniform shapes. Pierced perforation distortion problems can be caused by dull tooling, die clearance, punch deflection, a lack of lubrication or the punching method. Dull tooling requires more force to perforate and that creates more stress and distortion of the sheet. Too much die clearance for the material and thickness will cause the sheet to stretch and add to flatness problems. Punch deflection can be a particular issue for smaller holes (a ratio of two to one for the hole to thickness or less) and can cause distortion problems.



Perforation using piercing with visible burnished and fracture surfaces. Dull tools caused rougher fracture surfaces and metal overlap at the interface between the burnished and fracture surfaces making those perforations more susceptible to corrosion. © Catherine Houska



Water jet cutting of a stainless steel plate. © Lubos Chlubny/Shutterstock.com

Cluster punches, fully guided tools and custom coining tools can all help to reduce distortion but can add to manufacturing cost. When other possible causes of flatness problems have been eliminated, consider increasing the hole sizes and the spacing between them. Even with attention to detail, leveling may be required after piercing.

If the design requires higher hole density, varying hole sizes, unusual shaped perforations, sheet thickness outside of recommendations, or other conditions that can lead to piercing flatness issues, then boring is suggested. The method of

boring will be dependent on the sheet thickness and other requirements. Water jet cutting is often an excellent approach for more elaborate perforations on thinner sheets.

## 9.4 Water jet cutting

The water jet cutting process employs a nozzle to create a highly pressurized jet of water that carries fine abrasive particles, which are very effective at cutting both metallic and nonmetallic materials. The process uses high-capacity pumps and requires large amounts of water and power. This method is capable of cutting thick stainless steel sections (>100 mm) with no heat affected zone (HAZ) or alteration to the metallurgical structure of the workpiece. Although water jet cut edges are normally of high quality, the larger bevel angle of the cut surface can be an issue for thicker sections. The method generally is not cost effective for thin gauge sheets, but the cutting of multiple parts from a stack of thin sheets is possible.

## 9.5 Plasma cutting

Plasma cutting is the most common method for cutting all grades of austenitic stainless steel plate 25 mm (1 inch) thick



Plasma trimming of a GTA welded and hydro-formed austenitic stainless steel vessel head for sanitary applications. © DCI, Inc, St. Cloud, MN USA

and heavier. The evolution of plasma torch design has dramatically improved accuracy and edge quality, making the technology ideal for cutting shapes as well as straight lines. In some cases, the plasma-cut edge is good enough to use in service or as a weld joint without further preparation. Because plasma cutting does involve high temperatures and the melting of a thin zone of metal, as-cut edges can have reduced corrosion resistance. Portable plasma units are available for cutting formed parts and test pieces. Underwater plasma cutting reduces fumes.

With plasma cutting the grade of stainless steel and thickness of the cut are important factors to consider when selecting a plasma gas. Oxygen containing gasses should be avoided because the presence of oxygen will result in the formation of a surface layer of chromium oxide, which can deplete the underlying alloy of chromium and reduce corrosion resistance. A slight discoloration of the cut surface indicates chromium oxidation. If significant discoloration occurs, subsequent acid pickling or edge milling is required to restore corrosion resistance. Nitrogen assist gas should have a certified purity of at least 99.95% with a maximum oxygen content of 200 ppm. In addition

to N<sub>2</sub>, other commonly used plasma gasses for cutting of stainless steels include mixtures of either N<sub>2</sub> and H<sub>2</sub> or Ar and H<sub>2</sub>.

Variables such as the gas flow rate, arc current, nozzle design, and cutting speed can all impact the width, shape and quality of the cut. The manufacturer of the plasma cutting equipment should be consulted for specific recommendations for different grades and thicknesses of stainless steel.

## 9.6 Laser cutting

In laser cutting, a laser beam melts the material while a nitrogen jet blows the molten metal out of the kerf. The nitrogen gas prevents oxidation and loss of corrosion resistance. The nitrogen pressure used in laser cutting stainless steel is higher than the oxygen pressure used when cutting carbon steel, and must be increased as material thickness increases to remove the melted metal effectively. Compared to plasma cutting, laser cutting can yield much higher cutting speeds, narrow kerf widths and high-quality cut edges which typically can be used directly, without further edge preparation. The disadvantage of laser versus plasma cutting is the limited thickness capability of the laser process. With current laser cutting equipment it is only possible to cut stainless steels up to a maximum thicknesses of about 12 mm. Thin sections of HPASS and standard austenitic stainless steels are often cut to final dimensions using lasers, eliminating the need for additional machining. There is little difference between the laser-cutting characteristics of HPASS and standard grades.



Rapid cutting of stainless steel sheet using a laser cutting process.

# 10 Machining

The machinability varies greatly within the family of austenitic stainless steels, and depending on the grade, there can even be a large variation within a single grade. The high strength, high ductility, and high work hardening rates of austenitic stainless steels dictate the use of high-powered machining equipment. These properties tend to create significant abrasion at the tool-chip interface. The heat generated by deformation and abrasion is not removed efficiently through the workpiece, because of this stainless steel family's low thermal conductivity. These factors make austenitic stainless steels more difficult to machine than carbon steels. The higher strength of HPASS presents an even greater challenge. However, all these steels can be machined successfully when basic stainless machining principles (powerful machines, rigid setups, and positive feeds beneath the prior work hardened layer) are employed.

Austenitic stainless steels can be divided into four general categories with respect to machinability:

- Standard grades, including Types 304/304L and 316/316L in plate and sheet product forms.
- Standard grades with optimized machinability, typical of bar product, for example, grades modified with a slightly increased sulfur addition for increased machinability.
- Free-machining grades, usually in bar-product form such as type 303 or type 304 modified with advance ladle treatments to control the composition, size, shape and distribution of sulfide and oxide inclusions for maximum machinability.
- Higher alloyed grades and higher strength grades including HPASS.

The standard grades in plate and sheet are designed for optimum corrosion resistance, surface quality, and fabrication properties, but not machinability. The standard grades with optimized machinability still meet all specification requirements, but employ adjusted elemental compositions with special processing and controls, often proprietary, to get the best possible machinability. Optimized processing typically involves tight control of composition and microstructure, especially the size, shape, and distribution of non-metallic inclusions like sulfides and oxides.

Free-machining grades are designed for maximum machinability. The grades with the best machinability such as Type 303 have relatively high minimum sulfur levels resulting in improved machinability. Type 303 contains as much as 0.3–0.4% S compared to a typical 304 grade which routinely has a sulfur level of less than 0.005%. The sulfur produces sulfide inclusions that reduce cutting forces and aid chip formation. Although an increased sulfur level can improve machinability, it can also have some detrimental effects. For example, sulfide inclusions can substantially degrade corrosion resistance, toughness, ductility, and increase the susceptibility to weld solidification cracking. Type 303, for example, has significantly lower pitting corrosion resistance and is considered to be unweldable.

The HPASS are more difficult to machine than the standard grades for a number of reasons. Most importantly, they contain very low sulfur (0.001% S or less) to improve hot workability and corrosion resistance. Their high molybdenum content produces more tool wear. Finally, nitrogen is especially detrimental for machinability because it significantly increases strength, work hardening rate, and toughness.

## 10.1 General guidelines

The following machining guidelines are applicable to all stainless steels:

- Use powerful, rigid machines with extremely strong, rigid tooling and workpiece setups that provide for a depth of cut below the work hardened layer resulting from prior passes. These requirements are essential for machining the higher alloyed grades. Because of the extra loading imposed by the high work hardening rate of austenitic stainless steels, the tool's nose radius should be no larger than necessary for adequate tool life.
- The cutting edge should be as sharp as possible consistent with adequate tool life. Highly aggressive geometries are possible for the optimized-machining and free-machining grades, but sharp edges may not provide sufficient strength to the tool when cutting the higher alloyed grades.
- The feed rate should be high enough to cut below the work hardened layer left by the previous cut (**Figure 26**), typically at least 0.076 mm (0.003 inch).
- The cutting speed should be well below the limit for the tooling in terms of rigidity and vibration, to avoid formation of a work hardened layer.
- Tools should be changed or sharpened at regular intervals before they become dull. A dull edge leads to the formation of a thicker work hardened layer.
- Generous coolant/lubricant flow directed at the point of cutting is essential. Emulsions with extreme pressure (EP) additives are particularly beneficial.

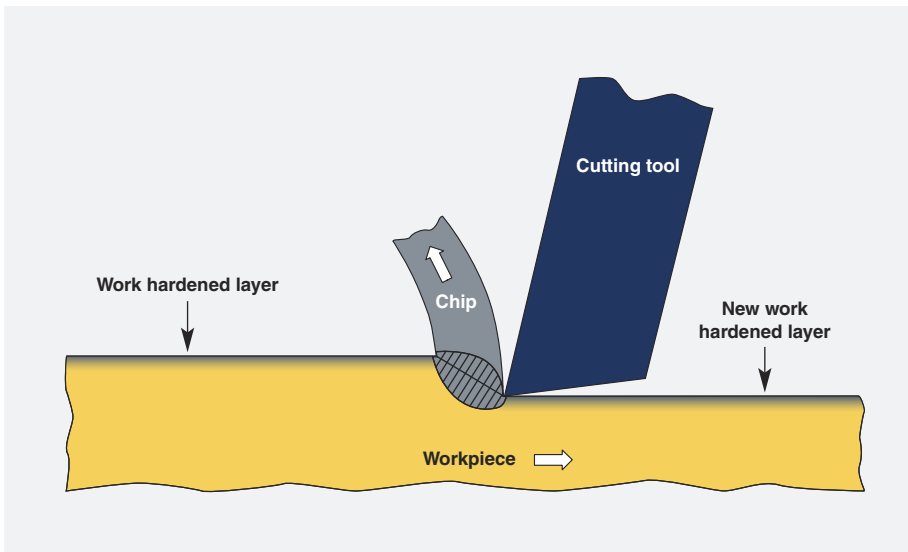

Figure 26: A positive cut removes material below the previously work hardened layer. (based on reference 20)

- Coated carbide inserts, especially those with positive chip breaker geometry, produce good results when machining both the standard stainless steels and the more difficult higher alloyed grades.
- High-speed steel tooling should be of premium grade quality.

## 10.2 Machinability index for different stainless steel grades

Stainless steels exhibit a wide range of machinability as a function of the properties of each grade and the range of possible machining conditions. No single machining index can fully represent all grades or conditions, but indices have value when comparing different grades. They can help to establish starting conditions when working with a new grade. **Figure 27** compares several stainless steel grades using a machinability index.

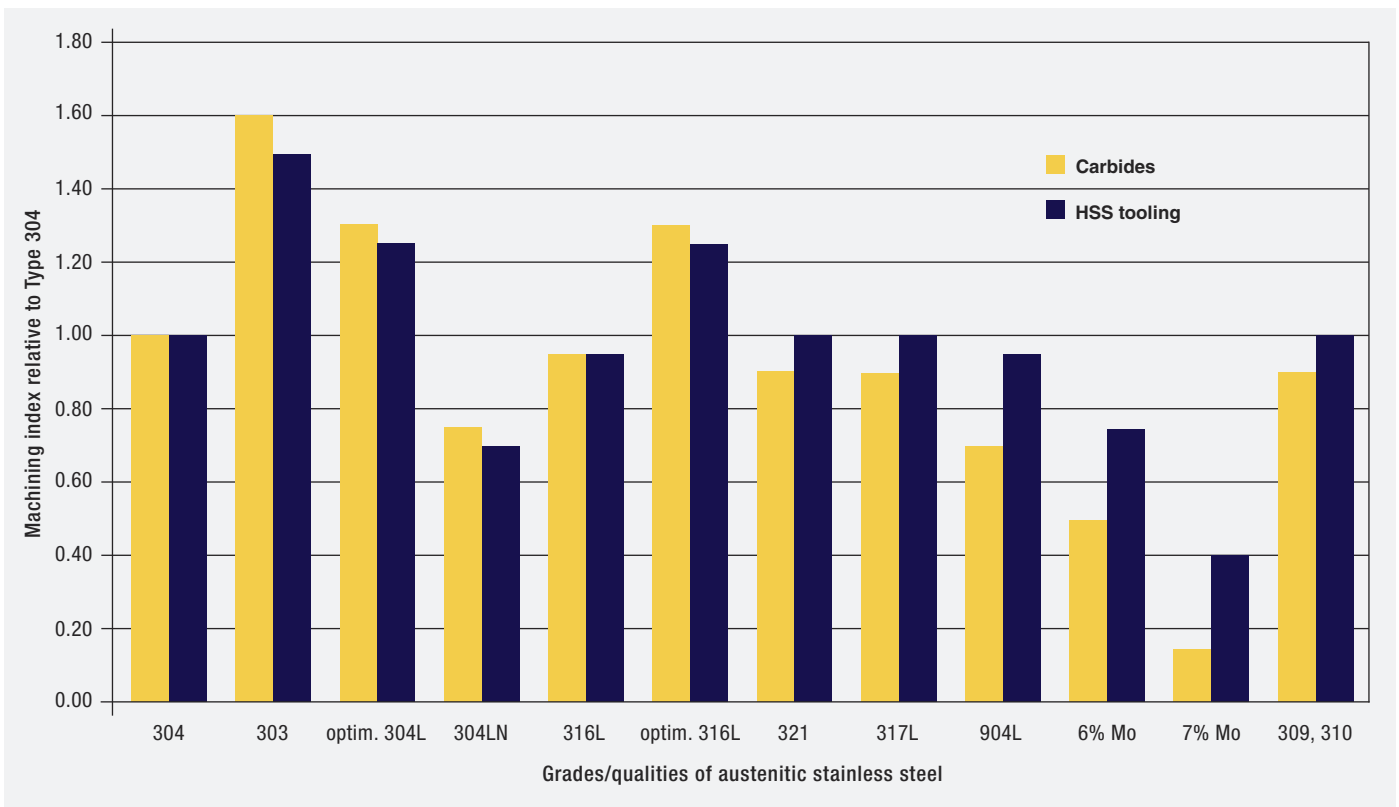
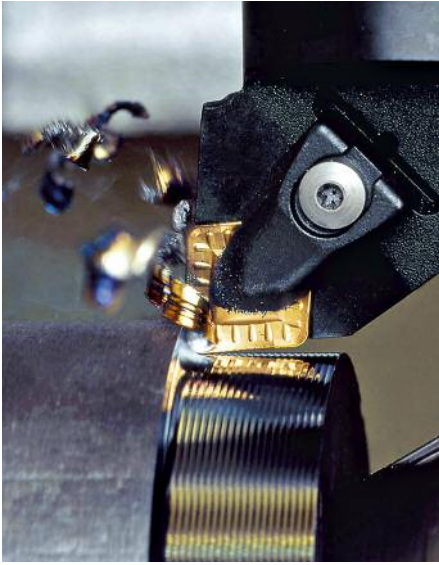

Figure 27: Machinability index for different austenitic stainless steel grades compared to standard Type 304. The relative machinability is similar for both carbide and high-speed steel tooling. (21)



Turning stainless steel using carbide with a built-in chip breaker. © Seco Tools

### 10.3 Turning

Turning austenitic stainless steels requires maximum rigidity and minimum vibration. Chip breakers are often required. Guidelines for turning austenitic stainless steels are provided in **Table 12**.

### 10.4 Face milling with cemented carbides

The following guidelines will give the best results when milling with cemented carbides:

- Use coated inserts or tough grades of uncoated inserts for roughing, and a depth of cut exceeding 0.5 mm

(0.020 inch). When a fine surface is desired, a harder uncoated insert, higher speeds, and lower feed rate should be used.

- When climb milling, use a feed rate of 0.10–0.25 mm (0.004–0.010 inch) per tooth, a highly positive axial rake, and a slightly negative radial rake with the width of cut being 1/2 to 3/4 of the diameter of the milling tool being used.
- The most important requirement for interrupted cuts is to eject the chip from the tool instead of carrying it around to be cut again. This is achieved by using sufficient speed to

Table 12: Guidelines for turning austenitic stainless steels.

Guideline	Carbides		High-speed steel tools
	Roughing	Finishing	
<b>Standard grades</b>			
Speed, m/min (feet/min)	120–150 (395–490)	150–210 (490–690)	20–25 (65–82)
Feed, mm (in/turn)	0.3–0.6 (0.012–0.024)	0.05–0.30 (0.002–0.012)	0.05–0.20 (0.002–0.008)
Depth of cut, mm (in)	2–5 (0.080–0.20)	0.5–2.0 (0.020–0.080)	0.5–2.0 (0.020–0.080)
ISO grade	P20–P35	P10–P15	
<b>Optimized grades</b>			
Speed, m/min (feet/min)	170–180 (560–590)	230–250 (750–820)	25–35 (82–115)
Feed, mm (in/turn)	0.3–0.5 (0.012–0.020)	0.1–0.3 (0.004–0.012)	0.3–0.5 (0.012–0.020)
Depth of cut, mm (in)	2–5 (0.080–0.20)	< 2 (< 0.080)	2–5 (0.080–0.20)
ISO grade	P20	P10	
<b>HPASS grades</b>			
Speed, m/min (feet/min)	60–80 (195–262)	80–100 (262–307)	4–6 (12–19)
Feed, mm, (in/turn)	0.3–0.6 (0.012–0.024)	0.05–0.30 (0.002–0.012)	0.05–0.20 (0.002–0.008)
Depth of cut, mm (in)	2–5 (0.080–0.20)	0.5–2.0 (0.020–0.080)	0.5–2.0 (0.020–0.080)
ISO grade	P30–P50	P25–P35	



obtain the appropriate temperature at the chip/insert interface so the chip does not stick to the insert edge or face. When roughing, it is best to use no coolant to achieve this condition. For fine finishing, coolant will help eject the chip clear of the tool, but a much higher speed and lower feed are required to assure that the chip does not stick to the tool.

- Guidelines for face milling parameters are provided in **Table 13**.



Side milling using carbide cutters. © Seco Tools



Face milling austenitic stainless steel with a carbide insert cutter. © Seco Tools

Table 13: Guidelines for face milling austenitic stainless steels.

Guideline	Carbides		High-speed steel tools
	Roughing	Finishing	
<b>Standard grades</b>			
Speed, m/min (feet/min)	160–190 (525–625)	190–220 (625–720)	15–20 (50–65)
Feed, mm (in/tooth)	0.2–0.4 (0.008–0.016)	0.1–0.2 (0.004–0.008)	0.10 (0.004)
Depth of cut, mm (in)	2–5 (0.080–0.20)	1–2 (0.040–0.080)	0.1 x tool diameter
<b>Optimized grades</b>			
Speed, m/min (feet/min)	180–210 (600–700)	305–350 (1000–1150)	25–30 (80–100)
Feed, mm (in/tooth)	0.2–0.4 (0.008–0.016)	0.1–0.2 (0.004–0.008)	0.10 (0.004)
Depth of cut, mm (in)	2–5 (0.080–0.20)	1–2 (0.040–0.080)	0.1 x tool diameter
<b>HPASS grades</b>			
Speed, m/min (feet/min)	40–60 (130–195)	60–80 (195–262)	6–8 (20–25)
Feed, mm (in/tooth)	0.2–0.4 (0.008–0.016)	0.1–0.2 (0.004–0.008)	0.10 (0.004)
Depth of cut, mm (in)	2–5 (0.080–0.20)	1–2 (0.040–0.080)	0.1 x tool diameter

## 10.5 Twist drilling with high-speed steel drills

When using high-speed steel tooling, it is very important to prevent overheating of the cutting tip. The poor thermal conductivity of austenitic stainless steel promotes overheating, which can lead to drill softening, loss of cutting edge, rapid further heating and catastrophic tool failure. Therefore, getting the coolant to the drill tip is critical. Through-drill coolant flow and pecking (withdrawing the drill periodically to allow coolant into the hole) are effective ways to achieve this.

High feed rates are necessary for drilling stainless steel, but they impose high

axial loading and can test the buckling limits of a drill. Maintaining a stable alignment of the drill perpendicular to the workpiece helps to avoid vibration and buckling. Use drills with a length no greater than necessary for the operation for good stability. Specific suggestions on speed and feed rates for standard and optimized austenitic grades as well as HPASS are give in **Tables 14a** and **14b**.

Guidelines for twist drilling stainless steel:

- Use a top angle of 130° for best chip breaking. A sharper top angle, perhaps 109°, produces a smoother wall but longer chips.

- Use self-centering drill point geometry and web thinning for larger diameter drills.
- Both cooling and lubrication are required. Use a 10% emulsion coolant with ample flow to the drill point. For solid drills, the drill should be withdrawn periodically and the hole flooded with coolant when the depth exceeds twice the drill diameter. Through-drill coolant eliminates the need to peck except for chip management.
- Speeds may be increased by 10% for TiN-coated drills and 10–20% with through-drill coolant flow.

Table 14a: Suggested parameters for twist drilling austenitic stainless steels with high-speed steel drills (metric units).

Drill diameter (mm)	Speed (m/min)/Feed (mm/rev)		
	Standard grades	Optimized grades	HPASS grades
1–3	6–10/0.05	10–12/0.10	5–8/0.04
5	10–12/0.10	12–14/0.20	8–10/0.08
10	10–12/0.20	12–15/0.30	8–10/0.15
15	10–12/0.25	12–15/0.40	8–10/0.20
20	10–12/0.30	12–15/0.45	8–10/0.25
30	10–12/0.35	12–15/0.55	8–10/0.30
40	10–12/0.40	12–15/0.60	8–10/0.35

Table 14b: Suggested parameters for twist drilling austenitic stainless steels with high-speed steel drills (English units).

Drill diameter (in)	Speed (ft/min)/Feed (in/rev)		
	Standard grades	Optimized grades	HPASS grades
0.040–0.120	20–33/0.002	33–40/0.004	16–26/0.0015
0.20	33–40/0.004	40–46/0.008	26–33/0.003
0.40	33–40/0.008	40–49/0.012	26–33/0.006
0.60	33–40/0.010	40–49/0.016	26–33/0.008
0.80	33–40/0.012	40–49/0.018	26–33/0.010
1.20	33–40/0.014	40–49/0.022	26–33/0.012
1.60	33–40/0.016	40–49/0.024	26–33/0.014

# 11 Heat treatment – annealing and stress relieving

Austenitic stainless steels cannot be hardened by heat treatment. Heat treatment of these alloys is used to remove the hardening effects of cold work, redissolve unwanted secondary phases, and reduce residual stresses to acceptable levels. For cold worked stainless steel, a heat treatment can also be used to produce a recrystallized structure with reduced grain size.

Solution annealing softens material after cold working and dissolves secondary phases that can precipitate during hot working or welding. The term “full anneal” often means that the material is in its optimum metallurgical condition, with secondary phases completely dissolved and the microstructure fully homogenized. This condition produces the optimum corrosion resistance and ductility. Because it is conducted at high temperatures, annealing in air produces a surface oxide or scale that must subsequently be removed by descaling and pickling to restore surface corrosion resistance.

Stress relief treatments reduce residual stresses that can develop during forming and welding, and lower the risk of distortion or stress corrosion cracking. Stress relief is usually performed at temperatures below those used for full solution annealing, and typically results in less scale formation. A full solution anneal heat treatment will also reduce residual stresses and can be used as an alternative to the lower temperature stress relief heat treatments. This is particularly useful with alloys that may be susceptible to precipitation of undesirable phases with a lower temperature stress relief heat treatment.

## 11.1 Solution annealing

### 11.1.1 Preparation

All grease, oil, cutting fluids, forming lubricants, crayon marks and other contaminants must be removed from the surface before annealing. Annealing can “burn” such contaminants into the surface, a condition which cannot be removed easily except by grinding. Carbon-containing contaminants can diffuse into the surface, carburizing

and sensitizing it, making it susceptible to intergranular corrosion in service. Because of this, a cleaning procedure before heat treatment is essential for maintaining product quality. Cleaning can be accomplished either by immersion or spraying with a chemical agent. Cleaning agents for the degreasing of stainless steels include hot alkaline solutions and chemical solvents. See Section 15 for additional information on appropriate stainless steel cleaning methods.



Degreasing of the surface is an essential cleaning step before any heat treatment. © Sandvik

Table 15: Heat treatment temperatures for several austenitic stainless steels based on ASTM A480 requirements.

UNS No.	Grade	Annealing temperature*	
		°C	°F
S20101, S30400, S30403, S30409, S31600, S31603, S34700	201, 304, 304L, 304H, 316, 316L, 347	1040	1900
N08020	Alloy 20	925 – 1010	1700 – 1850
N08904	904L	1095	2000
N08367	6% Mo	1105	2025
S31254	6% Mo	1150	2100
S31266	6% Mo	1150	2100
N08926	6% Mo	1100	2010

\* Minimum temperature unless otherwise indicated

Surface contamination with low-melting point metals like lead, copper and zinc must be avoided. It can lead to grain boundary penetration during annealing and result in so called liquid-metal embrittlement and intergranular cracking. These contaminants must therefore be removed from the surface prior to any high temperature processing such as annealing or welding.

### 11.1.2 Temperature

The minimum solution annealing temperature is the lowest temperature that will homogenize the microstructure and dissolve carbides and intermetallic precipitates. Annealing must be performed above this temperature to ensure complete precipitate dissolution and to restore corrosion resistance. The upper limit of the annealing temperature range is determined by the need to avoid warpage, minimize excessive scale that can be difficult to remove and avoid excessive grain growth. **Table 15** provides minimum annealing temperature guidelines for some austenitic stainless steels. HPASS require higher temperatures to

homogenize the microstructures so they have a higher solution annealing temperature than standard austenitic stainless steels.

### 11.1.3 Annealing time

Holding time at the solution anneal temperature of two to three minutes is sufficient to dissolve small amounts of carbide and other secondary phases, and to soften cold-formed material. When performing solution annealing treatments it is common practice to require a soak time of two to three minutes per millimeter thickness (six minutes per 0.1 inch) to ensure the solution anneal temperature is reached through the thickness of the component. If large precipitates are present, especially chi and sigma phases, longer holding times may be necessary.

Solution annealing for too long a time or at too high a temperature can cause excessive scaling that is difficult and costly to remove. Long annealing times also increase the likelihood of an unacceptable amount of dimensional distortion during the heat treatment. The high-molybdenum HPASS scale particularly rapidly in an air furnace. Molybdenum trioxide normally volatilizes and leaves the surface as a gas. If volatilization is inhibited, liquid



Batch heat treat process of stainless steel components. © Fondinox

molybdenum trioxide can accumulate on the surface and accelerate the oxidation process. This is called “catastrophic oxidation”. Precautions to minimize oxidation of high molybdenum steels are:

- Avoid conditions that inhibit volatilization (tightly packed loads and excessively tight furnaces).
- Do not reanneal heavily scaled material.
- Avoid long exposures above the minimum annealing temperature.
- Use the lowest practicable annealing temperature.
- Use a protective atmosphere

#### 11.1.4 Atmospheres

Air and oxidizing combustion gases are the most economical atmospheres for the annealing of stainless steels with satisfactory results. However, air annealing produces oxide scale that must be removed after annealing to restore corrosion resistance. Protective atmospheres like argon, helium, hydrogen, cracked ammonia, hydrogen/nitrogen mixtures, and vacuum, minimize scale formation but are more expensive. Bright annealing is typically performed in either hydrogen or cracked ammonia having a dew point of  $-40^{\circ}\text{C}$  ( $-40^{\circ}\text{F}$ ) or less. When properly executed, protective atmosphere annealing produces no visible scale, and no post-anneal cleaning is required.

#### 11.1.5 Cooling

Austenitic stainless steels may require rapid cooling after annealing to avoid precipitation of chromium carbides or other intermetallic phases (see section 3). The need for rapid cooling and choice of method depends on section size and grade.

In most situations, thin sections of Types 304L and 316L can be air-cooled



Water quenching of forged parts after they exit the solution annealing furnace. © Officine Ambrogio Melesi

without precipitating undesirable phases. As section size, carbon content, and alloy content increase, the need for more rapid cooling increases. HPASS require rapid cooling in all section sizes. Common methods are forced-air cooling and water spray or water quench cooling. In vacuum annealing, inert gas quenching can cool without scale formation.

If a material will be subjected to further hot processing after annealing, for example welding, it is best to provide maximum cooling, e.g., water quench, following the anneal. This increases the material’s tolerance for the detrimental effects of further thermal cycles. The possibility of distortion and the introduction of new residual stresses should be considered when choosing a cooling method.

#### 11.1.6 Post anneal cleanup

Because the heat treat scale is enriched in chromium, the metal immediately beneath the scale is depleted in chromium and has reduced corrosion resistance. Both the scale and the chromium-depleted metal must be removed to completely restore corrosion resistance.

The most common cleaning procedure is shot blasting to descale the surface, followed by an acid pickle to remove the

chromium-depleted metal. Full immersion is the most common technique used to pickle stainless steel, but pickling can also be performed with sprays, gels, and pastes.

Pickling acids are very hazardous, and it is extremely important to comply with all safety guidelines when using them (ventilation, gloves, goggles, protective clothing, etc.). The workpiece must be neutralized and thoroughly rinsed with ample amounts of clean low-chloride water after pickling. Spent fluids must be collected separately and disposed of in accordance with applicable hazardous waste regulations.

Section 15.2 provides detailed information about cleaning methods. The reader is urged to review this section carefully before undertaking any cleaning operation.

#### 11.2 Stress relieving

Stress relieving temperatures are lower than solution annealing temperatures, and are not high enough to dissolve precipitates. Stress relief removes some, but not all, residual stresses and will usually have minimal impact on the hardness of the material. Because of the lower temperature, the stress relief process is slow. Stress relief times are therefore in the range of hours, compared

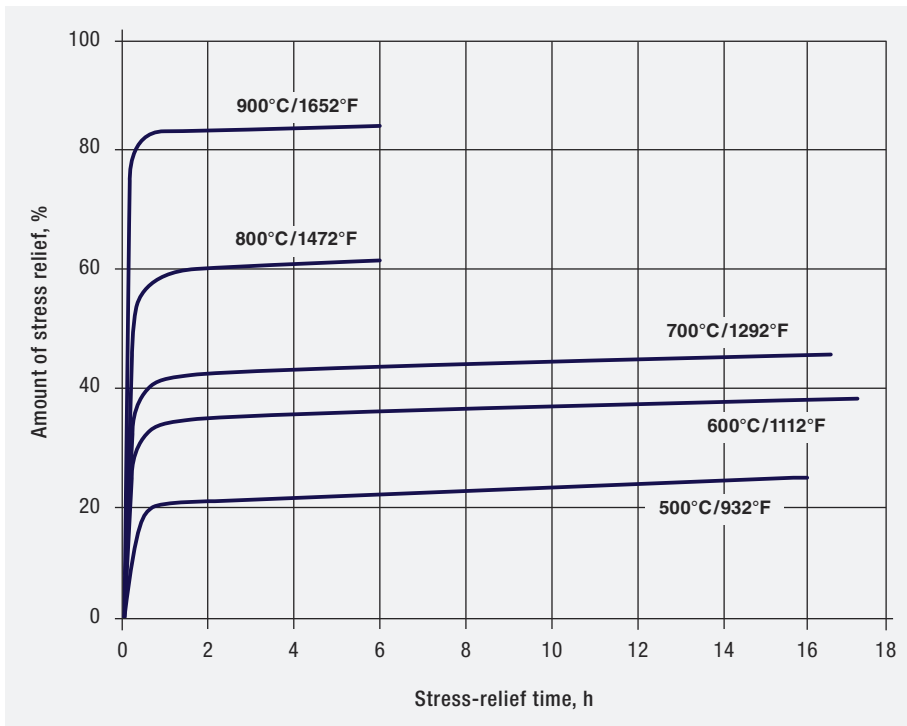

Figure 28: Residual stress relief in Type 347 stainless steel as a function of temperature and time. Residual stress before annealing was 230 MPa (33 ksi). (22)

to minutes for solution annealing. Stress relief temperatures often fall in the low end of the temperature range where secondary phase precipitation occurs. At these temperatures, annealing times must be chosen carefully to avoid precipitation that degrades corrosion resistance. This restriction often limits the amount of stress relief possible. The potential stress relief benefit must be weighed against the risk of sensitization when deciding whether to use a low temperature stress relief, an intermediate temperature stress relief, or a full solution anneal.

There are many cases where mixed construction, involving stainless steel and carbon or alloy steels, requires the carbon steel to be stress relieved. In these cases, the construction code or specification for the carbon steel controls the annealing time and temperature. The engineer must determine if the

required thermal cycle for the carbon steel will negatively affect the stainless steel. If so, a different stainless steel grade may be required.

A low temperature stress relief is typically conducted in the “safe” temperature range, up to about 540°C (1000°F). However, **Figure 28** shows that this treatment reduces stress by less than 40% of its initial value. A major advantage of the low temperature treatment is that there is no risk of sensitization. The figure also shows that an intermediate temperature treatment of 540 to 900°C (1000 to 1650°F) produces more stress relief. But these temperatures are in the range for the precipitation of carbides and intermetallic phases. Therefore, holding time must be severely restricted. Fortunately, most stress relief happens within the first half hour of reaching these intermediate temperatures.

With intermediate stress relief temperatures, the cumulative effect of all thermal cycles the workpiece has been exposed to must be considered. The stress relief cycle itself includes heating up, time at temperature, and cooling. The heat-affected zone (HAZ) of previously performed multi-pass welds may already have seen significant time at temperature before the stress relief. Adding more thermal exposure by stress relieving a part in the critical TTS range, can cause unexpected precipitation of secondary phases that deteriorate the corrosion resistance and mechanical properties of the HAZ. Most of the high chromium, high molybdenum HPASS form intermetallic phases in relatively short times, so only low temperature stress relief treatments should be considered for these grades.

The determination of how to cool the part after a stress relief treatment requires careful consideration. A high cooling rate, as with water cooling, can re-introduce stresses due to differences in thermal contraction. It can be very difficult to cool large complex components having variable cross-sections without introducing new stresses. For treatments in the time and temperature range for sensitization, a forced air cool to the bottom of the precipitation temperature range followed by a still air cool is an attractive option. A still air cool is usually satisfactory for use with low-temperature stress relief treatments.

Stainless steel surface preparation prior to stress relief is identical to that for solution annealing, and consists of a thorough cleaning to remove contamination. Low-temperature stress relief treatments will not produce the heavy scale typical of solution annealing, but they can cause surface oxidation. If the surface appears gold or blue after the treatment, it should be pickled to restore corrosion resistance.

# 12 Welding, brazing and soldering

Welding, brazing, and soldering are widely used methods to join stainless steels. The joining process for stainless steels must preserve both the corrosion properties and the mechanical properties of the base metal. Property differences between the joint and the base metal can be minimized with proper joint preparation, joining practice and final cleanup. This section offers general guidance on the welding and joining of stainless steels. Although HPASS use the same joining techniques as the standard austenitic grades, there are additional precautions to be taken.



Welded stainless steel storage tanks in a dairy plant. © iStock.com/Bim

## 12.1 Welding

### 12.1.1 Physical property effects on welding

Thermal expansion, electrical resistivity, and thermal conductivity are important physical properties that affect welding behavior. **Table 16** summarizes several of these parameters for carbon steel and for a standard stainless steel. Note that the physical properties of austenitic stainless steel are quite different from those of carbon steel.

A larger coefficient of thermal expansion (CTE) increases austenitic stainless

steels' tendency to distort. Because of this tack welds used for austenitic construction should be spaced more closely than in carbon steel, to control distortion.

The higher electrical resistivity of austenitic stainless steels, compared to carbon steels, reduces the electrical current necessary to generate the same amount of heat. This, coupled with a lower melting point, means that lower welding current is required to weld

austenitic stainless steels compared to carbon steels.

The low thermal conductivity of austenitic stainless steels tends to concentrate the heat near the weld. This produces a steeper temperature gradient and an increased tendency for shrinkage stresses and distortion, compared to carbon steel. Sluggish heat removal, due to the low conductivity, keeps the weld metal and heat-affected zone at higher temperatures for longer

Table 16: Physical properties of austenitic stainless steel and carbon steel.

Physical property	Carbon steel	Austenitic stainless steel 19 Cr – 9 Ni	Comment
Linear coefficient of thermal expansion	11.7 6.5	17.6 9.8	20–628°C (20–500°C for stainless): [x 10 <sup>-6</sup> /K] 68–1162°F (68–932°F for stainless): [x 10 <sup>-6</sup> /°F]
Relative thermal conductivity	100 100	28 66	%, relative to carbon steel at 100°C (212°F) %, relative to carbon steel at 650°C (1200°F)
Electrical resistivity	0.125 1.25	0.72 1.26	At 20°C (68°F) Ω·mm <sup>2</sup> /m At 885°C (1625°F) Ω·mm <sup>2</sup> /m
Approx. melting point	1540 2800	1425 2600	°C °F

times. This results in more time spent in the critical temperature range for forming of carbides or intermetallic phases.

### 12.1.2 Weld edge and fit-up

Molten stainless steel weld metal is less fluid than that of carbon steel, so weld penetration is not as deep for the same welding parameters. To compensate, stainless steel joints have a wider bevel, thinner root face and a wider root gap than carbon steel joints. Bearing these facts in mind when designing and preparing joints helps avoid burn-through and facilitates production of a full-penetration weld. Many different weld joint designs result in acceptable welds. A good collection of detail drawings for various weld joints is given in the Nickel Institute Publication No. 11007 (5).

#### 12.1.2.1 Edge preparation

Careful edge preparation is important for successful welding of austenitic stainless steels. Straight, clean and burr-free edges make joint alignment easier, assist with arc stability and produce welds with consistent penetration. Simply put, good edge preparation makes it easier for the welder to make a good weld. Machined edges are ideal, but grinding is an acceptable preparation technique if burrs are removed and the grinding produces a uniform gap.

#### 12.1.2.2 Edge cleanliness

**Oxides:** Stainless steels form a high melting point oxide during plasma or laser cutting. If the oxides are not removed from the cut edges before welding, they can contaminate the weld metal, creating internal stress raisers and sites for corrosion initiation. All oxides must be removed by machining or fine grinding to expose bare base metal before welding. Wire brushing, even when performed with a stainless steel wire brush, does not always remove tightly adhering oxides. Non-metallic grinding abrasives are suggested for surface preparation prior to welding.

**Organic contamination:** Organic contamination can cause weld cracks or porosity if not removed before welding. Carbon from organic contamination can dissolve in the stainless steel and lead to chromium carbide sensitization. Organic contaminants like oils, cutting fluids, or crayon marks must therefore be removed with appropriate solvents.

**Metallic contamination:** Copper, lead and zinc melted by welding heat can penetrate grain boundaries and embrittle stainless steel. Contamination with these metals is typically the result of contact with tooling or backing bars, or contact during storage or handling. These metals must be removed before welding to avoid the so-called liquid metal embrittlement. Grinding and pickling work best for removing metallic contamination.

#### 12.1.2.3 Fit-up, tacking and clamping

Proper fit-up prior to welding is critical in the HPASS which are fully austenitic and therefore require low heat input to avoid hot cracking. The welder should not have to “weave” in order to bridge a large or irregular root gap. Good fit-up provides a uniform gap width and alignment along the length of the weld. This can be achieved with precise edge preparation, and clamping or tacking of the weld.

**Table 17** shows appropriate spacing of tack welds in austenitic stainless

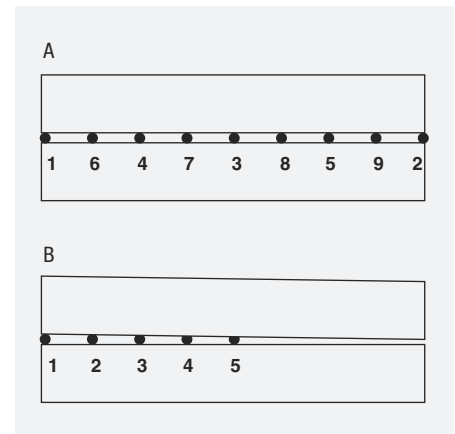

Figure 29: Proper tacking sequence to avoid closing of the gap during welding. A: Correct, B: Incorrect. (5)

steel, and **Figure 29** illustrates the proper tacking sequence for maintaining a uniform gap width in a straight weld. Tack welds in pipe or tubing that will be incorporated into the final weld should not be full penetration welds, and must be free of oxidation. It is very important that tack welds in heavy section weldments, not contribute to defects in the final weld. High-contour tacks or tacks with abrupt starts and stops should be contour ground. Welders should avoid striking or extinguishing the arc on a tack weld. Tack welds should be inert gas shielded, using a filler metal that is appropriate for the base metal.

Table 17: Recommended tack weld spacing as a function of thickness. (23)

Sheet thickness		Tack weld spacing	
mm	inch	mm	inch
1–1.5	0.04–0.06	30–60	1.2–2.4
2–3	0.08–0.12	70–120	2.8–4.7
4–6	0.16–0.24	120–160	4.7–6.3
> 6	> 0.24	150–200	5.9–7.9



Table 18: Suggested filler metals for welding of some more common stainless steels.

Base metal			Covered welding electrode (AWS)	Bare welding electrodes and rods (AWS)
Grade	UNS No.	EN No.	A5.4 (stainless) A5.11 (nickel alloys)	A5.9 (stainless) A5.14 (nickel alloys)
201	S20100	1.4372	E 308/E 308L <sup>1</sup>	ER 308/ER 308L <sup>1</sup>
201L	S20103		E 308L	ER 308L
304	S30400	1.4301	E 308/E 308L	ER 308/ER 308L
304L	S30403	1.4307	E 308L	ER 308L
316L	S31603	1.4404	E 316L	ER 316L
317L	S31703	1.4438	E 317L	ER 317L
317LM	S31725		See filler metals for 6% Mo stainless steel	See filler metals for 6% Mo stainless steel
317LMN	S31726	1.4439	See filler metals for 6% Mo stainless steel	See filler metals for 6% Mo stainless steel
904L	N08904	1.4539	E 385 or see filler metals for 6% Mo stainless steel	ER 385 or see filler metals for 6% Mo stainless steel
Alloy 20	N08020	2.4660	E 320 or E 320L	ER 320 or ER 320L
	N08028	1.4563	E 383	E 383
<b>6% Mo Stainless Steels</b>				
	S31254 <sup>2</sup>	1.4547	E NiCrMo-3, E NiCrMo-4, E NiCrMo-10, E NiCrMo-12, E NiCrMo-13, E NiCrMo-14.	ER NiCrMo-3, ER NiCrMo-4, ER NiCrMo-10, ER NiCrMo-13, ER NiCrMo-14.
	N08367 <sup>2</sup>			
	N08926 <sup>2</sup>	1.4529		
CN3MN <sup>2</sup>	J94651			

1 The “L” or low carbon grade or a stabilized grade is always used for welded fabrication except in a few instances where the slightly higher strength of the regular grade is more important than best corrosion resistance.  
 2 Any of these filler metals, which contain a minimum of 9% Mo, are suitable.

### 12.1.3 Filler metals

Table 18 lists filler metals commonly used to weld austenitic stainless steels. The table should be used only as a guide since alternates or proprietary filler metals are often available. For steels which are more highly alloyed than the 6% Mo grades, it is especially important to consult the alloy manufacturers’ data sheets and also determine that

the filler metal is suitable from both a corrosion and a mechanical properties viewpoint.

### 12.1.4 Shielding

Stainless steel should be shielded from air during welding to prevent oxidation of the weld and the heat affected zone (HAZ). Oxidation during welding can reduce corrosion resistance and

increase the amount of oxide inclusions in the weld metal, which can degrade mechanical properties. Depending on the welding method, shielding is achieved either by the use of a flux, as with the SMAW and SAW methods, an inert gas as with the GTAW and GMAW methods, or a combination of the two as with the FCAW weld method (see Section 12.1.5). Shielding gas also helps to stabilize the arc, and can affect penetration and

bead contour. **Table 19** lists shielding gases for different welding processes. Welding processes such as GTAW and GMAW that require gas shielding, may not be suitable for field or outdoor welding or for welding where drafts can disturb the gas shield and contaminate the weld with oxygen.

The backside of the weld should also be shielded to maximize corrosion resistance in the as-welded condition. Argon, nitrogen, and a 90% N<sub>2</sub>–10% H<sub>2</sub> Formier gas mixture, are used as backing gases. Nitrogen can dissolve in the weld pool, increasing the weld's

nitrogen content. Nitrogen increases the weld's strength and can increase the resistance to pitting and crevice corrosion.

A copper backing bar is often used when welding sheet material. The backing bar cools the weld, prevents burn-through, and helps contain the shielding gas to protect the back of the weld. It is important to avoid rubbing the stainless steel against the copper, which can transfer copper to the stainless steel surface and can cause cracking by liquid metal embrittlement if melted.

## 12.1.5 Welding processes

### 12.1.5.1 Gas tungsten arc welding (GTAW, also called TIG)

Gas tungsten arc welding is used primarily for sheet and tube welding and for the root pass on pipe welds. It is relatively slow but produces a clean, high quality weld that is free of slag and weld spatter. GTAW can be performed in all positions.

GTAW uses a non-consumable tungsten electrode to produce an electric arc that melts the base metal. The technique can be performed autogenously

Table 19: Shielding gases for various welding processes. (24)

Process	Shielding gas	Advantage / disadvantage
GTAW	99.95% Ar	Good penetration, low gas flow rate, low burn-through danger, produces high quality welds, expensive
	Ar + 1–3% N <sub>2</sub>	Limits loss of nitrogen in N-alloyed grades, improved corrosion resistance, might deteriorate tungsten electrode
	Ar + 1–5% H <sub>2</sub> + 10–30% He	Improved penetration and welding speed
	Ar + 2% N <sub>2</sub> + 10–30% He	Improved surface appearance with nitrogen alloyed grades
	Ar + 2–5% H <sub>2</sub>	Improved penetration and welding speed
GMAW	Ar + 2–2.5% CO <sub>2</sub>	Improved arc stability, wetting compared to pure Ar
	Ar + 1–2% O <sub>2</sub>	Improved arc stability, wetting compared to pure Ar
	Ar + 30–40% He + 1–3% CO <sub>2</sub>	Improved fluidity and bead appearance
	99.95% Ar	For fully austenitic stainless steels
FCAW	Ar + 15–25% CO <sub>2</sub>	Best surface appearance, arc stability and mechanical properties. Acceptable for all weld positions
	100% CO <sub>2</sub>	Increased penetration and side wall fusion. Acceptable in flat and horizontal positions, limited use out of position

Table 20: Typical welding parameters for GTAW. (23)

Tungsten electrode dia.		Current	Voltage	Typical section thickness	
mm	inch			A	V
1.6	0.063	50–120	10–12	<1.0	<0.040
2.4	0.094	100–230	16–18	1.0–3.0	0.040–0.120
3.2	0.13	170–300	17–19	>2.0	>0.080

(without filler metal), or with a bare filler wire fed manually in straight pieces or automatically from a coil. An inert shielding gas, introduced through the torch, protects the molten weld metal and tungsten electrode. Autogenous GTAW can be used to weld thin gauge standard grade stainless steel sheet, or to make the root pass for other welding methods. However, autogenous welding should not be used with HPASS unless they are post-weld solution annealed, because of a possible loss in corrosion resistance due to molybdenum micro segregation.

GTAW is best performed with a constant-current power supply and a high frequency arc-starting feature. Welding should be performed with a direct current straight polarity (DCSP) electrode negative procedure because reverse polarity (DCRP) causes electrode deterioration.

Commonly used electrodes include 2% thoriated tungsten, EWTh-2, and 2% ceriated tungsten, EWCe-2, electrodes (see AWS A5.12 ; EN ISO 6848). Arc control is aided by grinding the electrode to a conical point with a vertex angle of 20° for thin material to 65° for thicker material, and a small, rounded tip. The “correct” electrode end preparation depends on operator preference. For automated GTAW, a few tests under production conditions can help determine the ideal geometry to achieve the desired penetration.

A gas lens or a nozzle cap improves shielding gas coverage, prevents turbulence, and minimizes air aspiration

into the shielding gas. Gas flow should be initiated several seconds ahead of striking the arc and maintained for several seconds after the arc extinguishes to avoid oxygen contamination. **Table 20** summarizes typical weld parameters for GTAW.

**12.1.5.2 Gas metal arc welding (GMAW, also called Metal Inert Gas, or MIG)**

Gas metal arc welding enables fast deposition of large amounts of weld metal. It provides higher welding speed and lower costs than GTAW or shielded metal arc welding (SMAW).

In GMAW, the consumable bare wire is also the electrode, and is fed automatically from a coil through the torch. The process is usually semi-automatic where the welder guides the torch manually, but it can be automated for simple weld geometries. The shielding gas flows through the gun and protects the weld pool.

GMAW requires specialized equipment, including a constant voltage supply with variable slope and variable inductance control or pulsed arc current capability.



Manual GTA (TIG) welding. © iStock.com/Lekyum

GMAW should be performed with direct current reverse polarity (DCRP), electrode positive. There are three GMAW arc transfer modes:

- Short-circuiting transfer:** This mode requires separate slope and secondary inductance controls, and is useful for material up to approximately 3 mm (1/8 inch) thick. Metal transfer from the consumable electrode occurs by repeated short-circuits resulting in a relatively low deposition rate. This mode gives the lowest heat input, and is especially useful for thin sections where there is a risk of distortion. It can be used for out-of-position welding.
- Pulsed-circuiting transfer:** This mode requires a special power source that pulses the welding current and voltage. This combination provides the benefit of higher metal deposition rates than the short-circuiting transfer, while still using modest heat input. It can also be used for out-of-position welding.
- Spray transfer:** This mode provides a high deposition rate with a stable arc, but it has high heat input. The metal is transferred in the form of a fine mist of droplets. The mode is limited to flat position welding, and is used for sheet and plate 3 mm (0.120 inch) or thicker. It is economical when making long, straight welding runs in moderate to heavy welds.

**Table 21** lists typical welding parameters for the different welding transfer processes for pure argon gas shielding. These parameters will vary with different gas mixtures, so it is best to consult the gas supplier to obtain the parameters for a particular gas mixture.

### 12.1.5.3. Flux-cored arc welding (FCAW)

Flux cored arc welding can provide even higher deposition rates than GMAW. It is suitable for a wide range of metal thicknesses and can be used for out-of-position welding.

**Table 21: Typical welding parameters for GMAW as function of welding wire diameter and welding process. (23)**

Process	Wire diameter		Current A	Voltage V
	mm	inch		
GMAW short arc	0.8	0.031	90–120	19–22
	1.0	0.039	110–140	19–22
GMAW spray arc	0.8	0.031	150–170	24–27
	1.0	0.039	170–200	25–28
	1.2	0.047	200–270	26–29
	1.6	0.063	250–330	27–30
GMAW pulsed arc	1.2	0.047	75–350	24–30

**Table 22: Typical welding parameters for FCAW. (25)**

Process	Wire diameter		Current A	Voltage V
	mm	inch		
FCAW horizontal	0.9	0.035	80–160	22–28
	1.2	0.047	150–280	24–32
	1.6	0.063	200–320	26–34
FCAW vertical up	0.9	0.035	80–130	22–26
	1.2	0.047	140–170	23–28
FCAW overhead	0.9	0.035	80–150	22–27
	1.2	0.047	150–200	24–29

In FCAW, the flux-filled wire is fed automatically through the torch with the same equipment used for GMAW. The flux inside the wire provides a slag that protects the weld from the atmosphere. This slag supplements the gas shielding provided through the torch to protect the HAZ. In the case of self-shielding FCAW electrodes, the flux also generates a shielding gas, although this type is never used for demanding, corrosion-resisting applications. As in GMAW, the process is either semi-automatic or

fully automatic. Stainless steel FCAW consumables are covered by AWS A5.22, but very few FCAW wires are available suitable for HPASS. The two major gases used for stainless steel FCAW are argon with 15–25% carbon dioxide which gives best weldability or 100% carbon dioxide which gives better penetration. Gas flow rates are typically 20–25 liters/min. (0.7–0.9 cfm). Typical welding parameters for FCAW are given in **Table 22**.

#### 12.1.5.4 Shielded metal arc welding (SMAW, also called stick welding)

SMAW uses straight length “sticks” of metal wire coated with flux, that function as consumable electrodes. The flux shields the weld from oxygen and the slag that forms absorbs contaminants. This process is often used for repair welding of equipment in service, and for welds where it is difficult to clean the surrounding area. It is useful for field welding because no shielding or purging gas is necessary. A flux process is less susceptible to air contamination from drafts, making SMAW a good process for outdoor welding. SMAW requires a constant current power supply, and is normally carried out with DCRP electrode positive.

SMAW is a versatile process; it can weld complex geometries in difficult positions and in difficult locations. It is not economical for long straight welds that are candidates for automation or higher-efficiency processes.

The electrode covering, which contains gas-forming components, is based on a slag-forming flux. The specific flux chemistry affects arc stability, weld-bead contour, and weld cleanliness. Flux chemistry also determines how successful the technique is in out-of-position applications. Electrodes are available with a variety of flux formulations designed for specific welding positions, including out-of-position welding, vertical-down welding, and others.

The covering may also incorporate alloying elements into the weld. In this case, the bare wire in the center may be a standard grade stainless steel. Therefore, the coating on SMAW electrodes should never be stripped and the remaining wire be used as a GTAW bare-wire electrode; because the core wire may lack essential alloying elements, incorporated into the coating. Slag must be removed completely before the next pass, and before fabricated equipment is put in service.

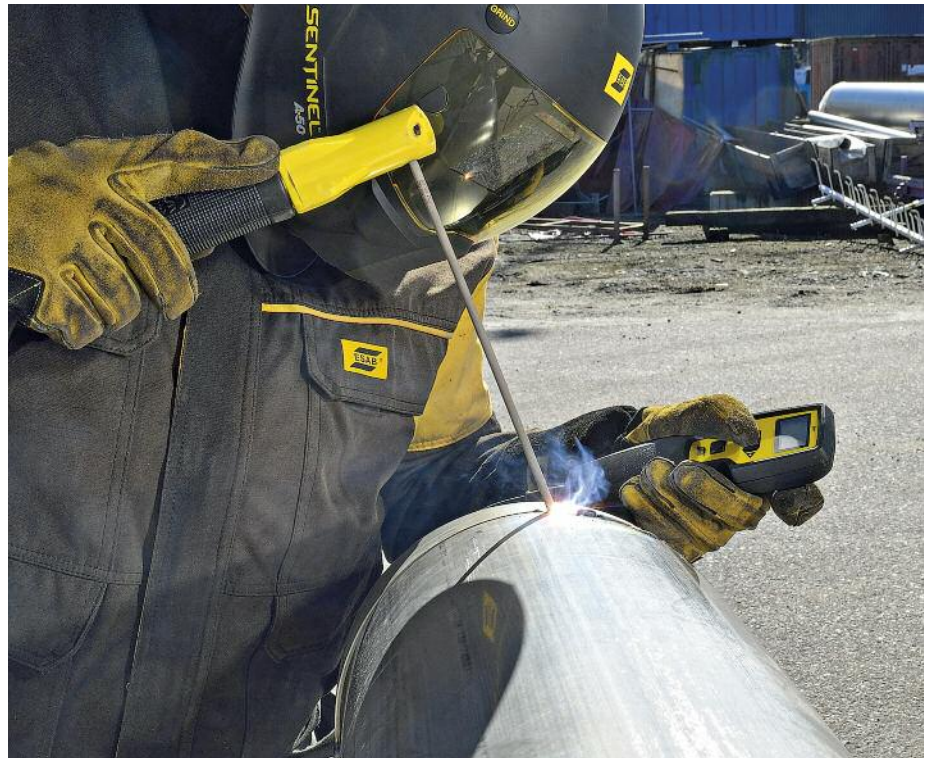

SMA welding of stainless steel. © ESAB Welding & Cutting

Welding rods are sold in airtight containers and, once opened, must be stored in a dry, low humidity location. If exposed to high humidity for any length of time, they should be dried in an electrode oven at 250–280°C (480–535°F) prior to use, to remove moisture that can produce weld porosity. Recommended welding parameters differ from producer to producer and with the alloy. **Table 23** provides general guidelines, but it is best to use the voltage and current suggested on the electrode container. For most HPASS alloys, lower currents than shown in the table should be used.

#### 12.1.5.5 Submerged arc welding (SAW)

In SAW, the consumable electrode is a bare wire, usually having the same composition used for GMAW. Flux powder is applied to the weld site. The flux powder melts and forms a blanket when the arc is struck. The melted flux powder forms a protective slag over the weld metal, and the unmelted

powder is usually recycled. The arc is not visible through the flux covering, so SAW must be automated.

SAW deposition rates are considerably higher than those of other welding processes. The process is well suited for components like heavy-wall vessels and piping. It is used for butt and fillet welding in the flat position or for horizontal-vertical fillet welding. It produces excellent as-welded surfaces, and requires minimal post-weld surface conditioning.

There are no specifications for stainless steel SAW fluxes, but a number of proprietary fluxes are available. Fluxes can be metallurgically neutral, acidic or basic in their effect on weld metal. The fabricator should consult with the flux manufacturer in selecting the correct wire-flux combination for the particular type of welding intended. HPASS fluxes tend to fall into the strongly basic category, whereas the standard alloys may use neutral to slightly basic flux.

Table 23: Typical parameters for SMAW for basic and rutile electrodes for different welding positions. (23)

Electrode			Current			
Type	Diameter		Voltage	Horizontal welding	Vertical, up-welding	Overhead
	mm	inch	V	A	A	A
Rutile	1.6	0.063	22–24	30–40	30–35	30–40
	2.0	0.078	22–24	35–55	35–40	40–50
	2.5	0.098	22–24	50–75	50–60	60–70
	3.25	0.128	22–24	70–110	70–80	95–105
	4.0	0.157	22–24	100–150	100–120	120–135
	5.0	0.197	22–24	140–190		
Basic	2.0	0.078	24–27	35–55	35–40	35–45
	2.5	0.098	24–27	50–75	50–60	55–65
	3.25	0.128	24–27	70–100	70–80	90–100
	4	0.157	24–27	100–140	100–115	125–135
	5	0.197	24–27	140–190		

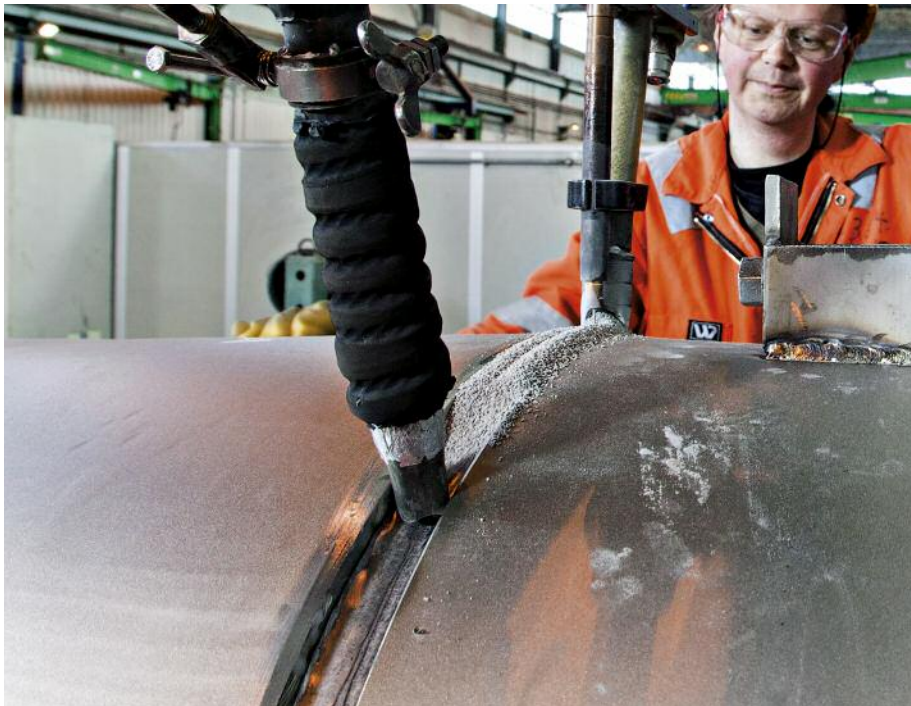

Attractive as high deposition rates may be, the high-heat input, large weld beads and low cooling and solidification rates of SAW can bring problems. In butt-welding applications, the standard grades of Type 304L and 316L (low carbon grades are preferred for high heat input rates) are easiest to weld. When SAW is used on HPASS, heat input and interpass temperature must be well controlled. See the guidelines in Section 12.1.8.3. As indicated in Table 18, these alloys are normally welded with Ni-Cr-Mo filler. SAW is particularly well suited for applying stainless steel weld overlays on carbon steel substrates in the flat position. Procedures specifying the correct filler metal/flux combinations to meet required weld composition limits are available (5, 23). **Table 24** provides some typical welding parameters.

Submerged arc welding. © ESAB Welding & Cutting

**Table 24: Typical welding parameters for SAW of standard stainless alloys using a neutral or slightly basic flux. (23)**

Wire diameter		Current A	Voltage V	Welding speed	
mm	inch			cm/min.	in/min.
2.4	0.094	200–350	27–33	30–60	12–24
3.2	0.125	300–600	30–36	30–60	12–24
4.0	0.157	400–700	30–36	30–60	12–24

**12.1.6 Dissimilar metal welding (DMW)**

Austenitic stainless steels can be easily welded to different austenitic grades, to duplex stainless steels and to carbon and low-alloy steels. Welding dissimilar metals requires that both, the properties of the metals to be joined and the filler metal be considered, because welding creates a new alloy made from the base metals and the filler metal. Detailed information on dissimilar metal welding can be found in Nickel Institute Publication No. 14018 (26), but the following discussion provides some background information.

When welding stainless steel to carbon or low-alloy steel, the mixed weld composition should not form significant martensite. Martensite causes low weld ductility and is prone to hydrogen-related defects. After dilution, the weld should contain austenite and a minimum of 5% ferrite to provide good resistance to hot cracking. The weld composition can be estimated by assuming the weld consists of approximately 70% filler metal and 30% base metal (15% from the stainless steel and 15% from the carbon steel). The Schaeffler Diagram (Figure 5) can then predict the phases present in the weld. Stainless steel filler with a higher ferrite content (E309L, E309MoL) is a good choice for joining standard austenitic grades to carbon steel. With a leaner filler metal like Type 308 and dilution from ordinary steel, the martensite that forms may

embrittle the weld. When welding HPASS to carbon steel the choice of filler will depend on which HPASS grade is being welded and specific advice can be found in references 23 and 26.

Dissimilar metal welds must meet the mechanical property and corrosion resistance requirements of the service environment. The weld metal should be equal to or stronger than the weaker of the two base metals. Its corrosion resistance should equal or exceed that of the less resistant base metal. If the service environment involves thermal cycles, the thermal expansion of the weld and the base metals should be as similar as possible to minimize thermal fatigue failures. However, in welds between carbon or low-alloy steels and austenitic stainless steels, the difference in thermal expansion is not considered significant when the service temperature is 425°C (800°F) or lower.

When joining two different grades of molybdenum-containing austenitic stainless steel, a filler metal, with a molybdenum content equal to the higher molybdenum-alloyed base metal should be used. This is also true when joining austenitic and duplex stainless steels.

**12.1.7 Weldment quality considerations**

Stainless steel weldments (weld metal and HAZ) must be both corrosion resistant and structurally sound,

according to the requirements of the particular application. Normally the weld is expected to be at least as corrosion resistant as the base metal with a preferably slightly higher strength level. We can divide weld quality into two distinct areas – physical weld defects (12.1.7.1–12.1.7.5) and metallurgical issues (12.1.7.6–12.1.7.9). Both can impair corrosion resistance or strength, and thus should be avoided. Unacceptable weldments should be repaired in a way that restores the required properties. Most of the physical weld defects are well known from carbon steel welding, whereas the metallurgical issues are unique to stainless steels. The following provides guidance to help ensure proper quality weldments.

**12.1.7.1 Incomplete joint penetration**

Incomplete joint penetration occurs most often in tube or pipe butt welds, or other butt welds that are not double-welded. It creates a crevice that can initiate corrosion and trap dirt and contaminants, allowing them to accumulate. The crevice lowers the strength and corrosion resistance of the weld, and is very difficult to sanitize (clean). High quality butt welds demand full penetration joints. Otherwise, the joint’s mechanical strength and fatigue resistance may be substantially reduced. To avoid these problems, it is important to use a suitable weld joint design or back gouge and weld the reverse side when possible.

**12.1.7.2 Porosity**

Surface porosity offers a haven for dirt, and other contamination that can initiate corrosion. Surface porosity is difficult to properly clean and sanitize because it traps dirt and bacteria. Moisture usually causes weld porosity and it can come from electrode flux, shielding gas or the workpiece surface. Careful attention to electrode drying, gas chemistry and cleaning practices minimize surface porosity. It is also important to establish porosity acceptance levels to guide radiographic inspection and visual inspection of weldments.

### 12.1.7.3 Arc strikes and weld spatter

Arc strikes and weld spatter act as crevices and can initiate crevice corrosion. To minimize these defects, the welder should strike the arc in the weld joint instead of next to the weld. If arc strikes are present, they should be removed by fine grinding.



Weld spatter and an irregular weld bead should be avoided. © Outokumpu

### 12.1.7.4 Microfissures and hot cracks

Microfissures are tiny, short fissures or cracks that may occur in austenitic stainless steel welds. They rarely propagate and cause a weld structural failure, but in some environments, they may initiate localized corrosion. Hot cracking, or more correctly weld solidification cracking, however, is a serious weld defect that must be avoided.

The compositions of the most commonly used filler metals, Types 308(L) and 316(L), are adjusted to obtain ferrite contents of typically 5 to 10 percent, which greatly improves resistance to microfissuring and hot cracking. Ferrite absorbs shrinkage stresses and has higher solubility for sulfur, phosphorus and certain other impurities that embrittle austenite. Microfissures and hot cracks do not normally occur in standard grade welds containing the recommended amount of ferrite, but they can occur in these grades under conditions of very high heat input, high weld restraint, or in concave weld contours. The American Welding Society (AWS A5.4) defines a Ferrite Number (FN) to express the amount of ferrite in a weld. The FN corresponds roughly to

the volume percent of ferrite present in the weld of austenitic stainless steels. The pictures below show weld metal with two different ferrite contents.

The filler metals intended for welding HPASS do not produce welds containing ferrite, so welds in these grades are prone to microfissures and hot cracking. HPASS filler metals contain extremely low phosphorous and sulfur to minimize these problems. Strict control of heat input and other weld parameters is also necessary for good results when welding HPASS. A common limit on heat input is 1.5 kJ/mm (38 kJ/in).

Any practice that increases the size of the molten weld pool (e.g. excessive weaving) should be avoided when welding austenitic stainless steels. A large weld pool creates greater solidification shrinkage stresses. Large weld pools can also lead to larger grain size in the weld and the heat affected zone (HAZ). Coarser grain material has less grain boundary area than fine grain material. This leads to higher impurity concentrations at grain boundaries, and a possible reduction of corrosion resistance. Excessive shrinkage stresses and excessive concentration of trace elements in grain boundaries promote hot cracking.

### 12.1.7.5 Other defects

Other weld defects such as lack of fusion and entrapped slag between weld

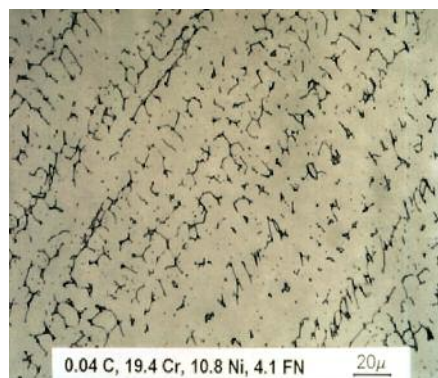

passes are generally unacceptable in austenitic stainless steels as they are in carbon steels. Trapped slag on the surface of the weldment exposed to the corrosives is an area where pitting can initiate. Similarly, a rough surface finish on a weld will reduce its corrosion resistance. Undercut may significantly reduce the fatigue properties of the weldment. Excessive reinforcement, either in the root or cap of the weld, may also be detrimental to the performance of the weld.

### 12.1.7.6 Surface oxides

Heat tint on the interior surface of tube or pipe welds can be a concern for many applications. There are a number of methods to eliminate or minimize the heat tint oxide. One is to use good internal inert gas purging techniques. When making butt joints using orbital GTAW, good joint fit-up and inert gas purge is necessary in order to achieve welds essentially free of heat tint. With manual GTAW root pass welding, some degree of heat tint often occurs. Depending on the amount of heat tint and the intended service, it may be necessary to remove the oxide by pickling or mechanical polishing.

Heat tint substantially reduces pitting and crevice corrosion resistance, especially in standard austenitic stainless steels. Another potential problem is microbiologically influenced corrosion (MIC). Heat-tinted areas are also

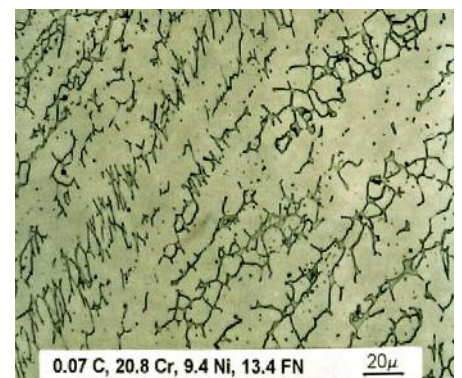

Austenitic stainless steel weld metal with different ferrite contents. © Lincoln Electric



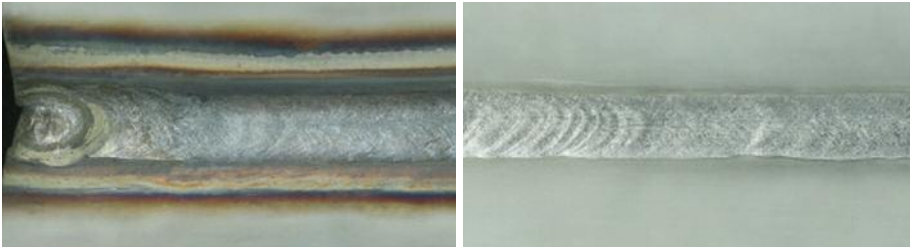

Heat tint on a high quality GMA weld and on the HAZ (left). Post-weld cleanup through pickling restores the corrosion resistance of the weld (right). © Outokumpu

more susceptible to MIC and it has been found in untreated water service, particularly under low flow or stagnant conditions. Failing to drain and dry systems after hydrostatic testing with ordinary water can also induce MIC.

There are two challenges to establishing an acceptance criterion for heat tint on welds where it cannot be removed. The first challenge is how to measure or quantify the degree or amount of heat tint present on a weldment. A number of industries use heat tint color photograph charts that can be used to visually characterize the level of heat tint by comparing weld heat tints to the photographic charts. One such chart is available in AWS D18.1 and D18.2. The second challenge is to establish what amount of heat tint is acceptable for a specific service.

Reduced corrosion resistance from heat tint is more pronounced in the standard stainless steels (e.g. 304L and 316L) than in the HPASS. When it may be extremely difficult or costly to remove heat tint, designers should consider a more corrosion-resistant grade to better accommodate its effects.

#### 12.1.7.7 Sensitization

Standard grades with elevated carbon content can be sensitized by relatively short exposure to temperatures between 480 and 900°C (900 and 1650°F) (Figure 8). This can result in susceptibility to intergranular corrosion in aqueous or acidic environments (section 6.3). However, modern standard grades are

in reality often “L-grades”, typically containing less than 0.03% carbon. They are therefore resistant to sensitization during normal fabrication welding, provided there is no other subsequent thermal processing. For example, it takes approximately one hour to sensitize a Type 304 stainless steel with 0.042% carbon at its fastest sensitization temperature (Figure 8). This is far longer than the typical time at temperature during welding. Even so, exposure in the critical temperature range during welding should be limited for heavy sections.

Using low carbon grades helps to avoid sensitization in welded heavy sections and in components subjected to post-weld heat treatment. Type 304L tolerates a long time at temperature, which permits safe cooling even for heavy sections (Figure 8). Even stress relieving a mixed stainless steel – carbon steel construction might be possible when using L grades.

However, high temperature grades often contain a minimum of 0.04% carbon (Type 304H) for improved elevated temperature strength. Fortunately, aqueous corrosion due to sensitization is not normally a concern in elevated temperature applications. These grades generally require a high-carbon filler metal to provide adequate high-temperature weld strength.

The stabilized grades Type 321 and 347 may be vulnerable to narrow knife-line attack if they are exposed to temperatures in the 480 to 900°C (900 to 1650°F) range during welding. If knife-line attack

is a concern, a post-weld solution anneal, followed by a stabilizing heat treatment should be specified. See Section 6.3.2 for a discussion of the mechanism of knife-line attack.

Most of the HPASS have an even lower maximum carbon content than the standard “L-grades,” as they would sensitize faster than the standard grades for the same carbon content. However, during welding the formation of secondary phases is generally far more of a concern in HPASS than sensitization.

#### 12.1.7.8 Intermetallic phases

Intermetallic phases sigma and chi can form in the temperature range of 500 to 1050°C (930 to 1925°F). Stainless steels containing sigma and chi phases have substantially lower corrosion resistance and toughness. The presence of about 5% sigma phase reduces the impact toughness by 50%.

Increased chromium and molybdenum levels strongly promote the precipitation of intermetallic phases and sigma and chi can form in HPASS in less than a minute in the critical temperature range. Therefore, welding parameters for these materials must include low heat input (below 1.5 kJ/mm [38 kJ/in]) and an interpass temperature not to exceed 100°C (212°F) to minimize the time in the critical temperature range. The interpass temperature should be measured on the weld bead at the end of the pass, with an electronic thermocouple for accuracy. Temperature-sensitive crayons should not be used because they can contaminate the weld.

The precipitation of any intermetallic compounds in standard grades typically requires a time in the undesirable temperature range of 100 hours or longer. Because of these slow kinetics, sigma and chi precipitation is not an issue during fabrication of standard grades but could be a concern during long term high-temperature service.

### 12.1.7.9 Weld segregation

HPASS with their high molybdenum content are particularly prone to microsegregation of molybdenum in the weld metal. This effect occurs during solidification because the first metal to solidify contains less molybdenum than metal that solidifies later, creating microscopic gradients in molybdenum content. In a 6% Mo stainless steel, low-molybdenum regions may contain an area with significantly lower corrosion resistance.

HPASS, therefore, require welding with an over-alloyed filler metal to compensate for microsegregation. The recommended nickel-base filler material for 6% Mo stainless steels contains a minimum of 9% molybdenum, which assures a minimum molybdenum content of 6% in the regions that solidify first, preserving good weld metal corrosion resistance.

HPASS fabrications that cannot be post-weld annealed should not be welded autogenously (without a filler metal), because of the microsegregation problem. Autogenous welds are acceptable only if the welded construction is subsequently solution annealed to homogenize the weld and reduce microsegregation, which restores corrosion resistance.

## 12.2 Brazing and soldering

Brazing and soldering are joining methods in which base metal components are joined with a fusible filler alloy, having a melting point well below that of the base metal. With these techniques, the base metal always remains in the solid state. The difference between soldering and brazing is primarily the processing temperature. The American Welding Society defines soldering as metal coalescence below 427°C (800°F). Although methods above 427°C (800°F) are technically brazing operations, the term “hard soldering” has been applied to silver brazing, which typically requires temperatures in the range of 595 to 705°C (1100 to 1300°F).



Soldering of stainless steel is not difficult, but requires a specialized flux.  
© BRANDT Edelstahl Dach GmbH

All stainless steels can be soldered and brazed. Requirements for good soldering and brazing of stainless steels are similar for nearly all grades. Surfaces should be clean, a non-corrosive flux should be used, and care must be taken to avoid sensitization if the process takes place in the sensitization temperature range. Differences among grades relate primarily to their oxidation resistance. The more oxidation resistant grades often require fluxes that are more aggressive.

### 12.2.1 Brazing

Most stainless steels are brazed with filler alloys that fall into the following categories:

- silver alloys – BAg group
- nickel alloys – BNi group
- copper alloys – BCu group
- gold alloys – BAu group

Alloy selection is based on the mechanical properties, corrosion resistance, and high-temperature properties required by the service environment.

Silver alloys (Ag-Cu-Zn and Ag-Cu-Zn-Cd) are the most widely used and can be used for all austenitic grades. Cadmium-

containing alloys are prohibited in the dairy and food industries because of cadmium's toxicity. Cadmium-free alloys should be used whenever possible from a health and safety standpoint.

Brazing temperatures for most silver alloys are in the sensitizing temperature range, so the process can result in chromium carbide precipitation and sensitization. For this reason, Type 347 or the low carbon grades are preferred when silver brazing. Because most silver alloys contain copper and/or zinc, overheating for extended times must be avoided to prevent liquid metal embrittlement of the stainless steel.

Nickel alloys are usually chosen for their excellent corrosion resistance and good strength at higher temperatures. These alloys consist primarily of Ni-Cr-B-Si alloys. Most nickel-alloys require high brazing temperatures (927 to 1204°C, 1700 to 2200°F). Although this temperature range is above the sensitization temperature, the metallurgical impact of brazing temperature and cooling cycle on the base metal must be evaluated especially for HPASS.

Copper alloys consist predominately of pure copper, and have high brazing temperatures. Their flow characteristics are better than those of Ni fillers, permitting a tighter joint fit. Unfortunately, the copper alloys have lower corrosion and oxidation resistance, which limits their applicability.

Gold alloys are used in special applications where corrosion resistance and joint ductility requirements preclude the use of other alloys. The gold alloys consist primarily of Au-Cu and Au-Pd-Ni alloys. Their high cost restricts their use to niche applications like aerospace equipment.

Stainless steel assemblies are usually brazed in a furnace with a controlled inert atmosphere or a vacuum. In strongly reducing or inert atmospheres, a flux is not required. Torch brazing always requires a flux. Induction and resistance brazing require flux when not performed under protective atmosphere or in vacuum.

Many special flux compositions are available for use with stainless steels. Fluxes like AWS 3A and 3B are suitable. These fluxes contain boric acid, borates, fluorides, fluoborates and a wetting agent. The flux must be removed completely after brazing to avoid corrosion by flux residue.

### 12.2.2 Soldering

Stainless steels are typically soldered with tin-lead or tin-silver solder compositions, although the industry is moving to eliminate lead-containing

Table 25: Advantages and limitations of soldered joints.

Advantages	Limitations
Produces a liquid- and gas-tight joint at low temperatures	Possible reduced corrosion resistance at the joint
Avoids high temperature metallurgical effects	Rapid loss of strength with increased temperature
Minimum thermal distortion	Low strength compared to the stainless steel base metal and welded joints
Lower costs relative to other methods	Appearance may be sacrificed
Seals crevices and round corners	Slow compared to welding methods

solders. Soldering is primarily a joining technique, but it also can eliminate crevices and sharp corners. Most standard austenitic stainless steels have good solderability, with the exceptions of Ti stabilized grades like Type 321 and the oxidation resistant grades. The high chromium, content of HPASS places them among the oxidation-resistant grades that present more difficulty. Standard soldering fluxes cannot remove the tenacious oxides of HPASS, which impede surface wetting by the solder. Strong fluxes are required to solder these alloys successfully.

The flux must remove the stainless steel's passive film to ensure wetting of the workpiece by the solder. Acid-based fluxes are most commonly used, and commercial fluxes designed specifically for stainless steels are available. Phosphoric acid and hydrochloric acid fluxes have produced good results in the standard grades. The more oxidation resistant stainless steel grades with

high Cr, Mo, Al or Ti contents require fluxes that contain hydrofluoric acid. It is important to clean and neutralize the surface thoroughly after soldering to prevent future corrosion problems by highly corrosive flux residue. The hydrofluoric acid in these fluxes requires special practices to ensure their safe handling and application.

Surface finish also plays a role in wetting. Pickled finishes (No. 1 or 2D) provide better solderability than smoother finishes such as 2B or BA (bright annealed) finishes.

The soldered joint introduces a dissimilar metal that could be susceptible to galvanic corrosion. Because the solders are low melting, "soft" materials, the joint strength is that of the solder. Joints that incorporate laps and sleeves have higher strength than simple butt joints because of their larger bond area. **Table 25** summarizes advantages and limitations of soldering stainless steels.

# 13 Mechanical joining methods

All common mechanical joining methods can be used with stainless steels. These methods are primarily ambient-temperature processes and, with the exception of hot riveting, there is little concern for oxidation or precipitation of undesirable phases. However, a few potential issues should be considered when mechanically joining stainless steels. One is the crevice that is inherent to mechanical joints, which can cause them to be susceptible to crevice corrosion in chloride-containing media (see 13.2.1). Another is the possibility of galvanic corrosion in joints made from dissimilar metals (see 13.2.2). Mechanical joints also tend to have lower strength than welded joints and are not recommended for hygienic applications where cleanability is critical.

## 13.1 Joining methods

### 13.1.1 Bolting and screwing

Although the strength and galling properties of duplex stainless steels and precipitation hardened stainless steels

are better suited for fastener applications, austenitic stainless steel are often used. Bolts and screws are readily available in the standard grades but are not available in HPASS. Austenitic stainless steel fasteners in the annealed condition are prone to galling, so cold worked, high strength, or galling resistant grades are preferred. Some of the 200 series austenitic grades such as S24000 and S21800 are more resistant to galling than other austenitic grades and are often chosen for fastening systems. Important mechanical issues with bolted joints include the position of bolt holes and the tension and shear capacity of the connection. The strength of a bolted joint is usually less than that of a welded joint. Guidelines for the design of bolted connections are available in Ref. 27.

### 13.1.2 Riveting

Standard grade stainless steel rivets are available in most common head designs and shank diameters. Rivets should be loaded in shear, not tension, so the mating surfaces must be clean and



Folding knife with an austenitic rivet to provide strength and corrosion resistance in the joint. © Victorinox

free of burrs, and the rivet holes matched precisely to assure proper fit-up. The driving and head forming of a rivet involves cold deformation of the rivet material. Austenitic stainless steels, with their higher work hardening rates than carbon steel, require more powerful riveting equipment.

Riveting can be performed cold or hot. Cold riveting avoids scaling and the expense of heating. Hot riveting provides additional compressive tightening as the rivet shank cools and contracts. Austenitic stainless steel rivets are generally heated to 1065 to 1150°C (1950 to 2100°F) prior to hot riveting. The operation should be performed before the temperature drops below 930°C (1700°F).

### 13.1.3 Clinching

Clinching is a periodic deformation that serves to crimp the material together. It is an alternative to riveting or spot welding, and can be applied to any thin, ductile material. Clinching and adhesive bonding are often combined to form a



Bolted flange connection. © Super8/Shutterstock.com

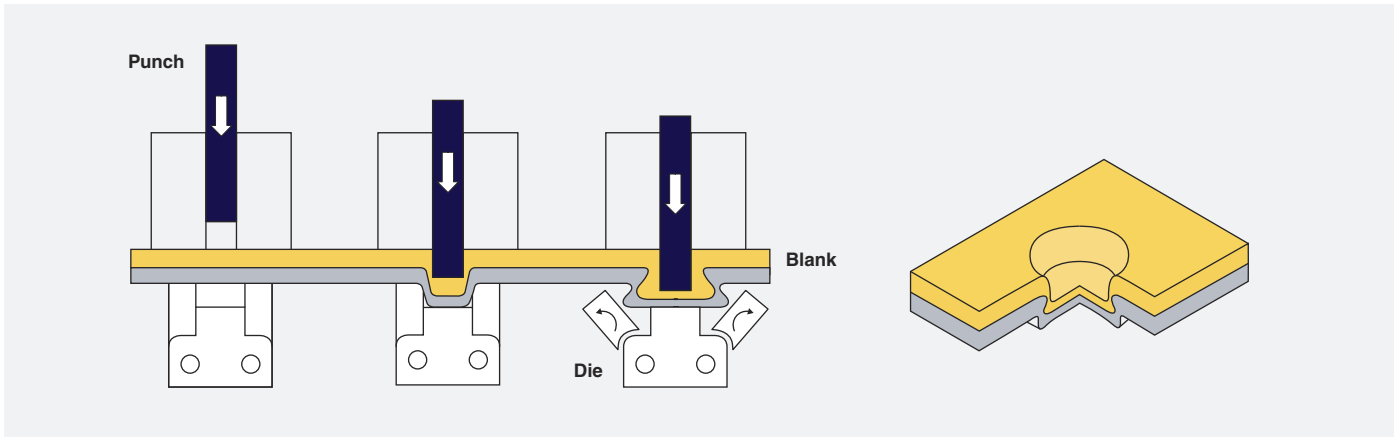

Figure 30: Clinching process. (based on 28)

hermetically sealed joint that prevents fluid from entering the crevice area.

### 13.1.4 Lock seaming

Lock seaming bends the edges of two sheets through an angle of 180° to produce a tight seam (**Figure 31**). This technique is most commonly used with stainless steel sheet and strip of 1.6 mm (0.062 in) thickness or less. It is widely used in stainless steel roofing applications and in the manufacture of household appliances. Seam adhesive applied to the joint surfaces enhances sealing of the seams. Joints of this type have tight crevices that make cleaning more difficult and increase the risk of crevice corrosion. If the service environment permits, the crevices may be filled with an appropriate solder to avoid corrosion problems.



This stainless steel standing seam roof uses the double lock technique to provide a permanent seal in this harsh mountain environment, characterized by high winds, heavy snow loads and extreme temperatures. © Roofinox

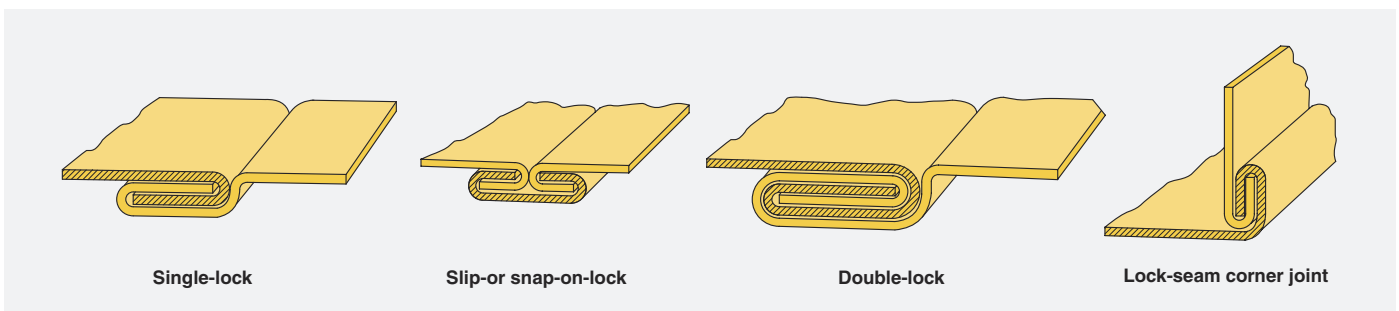

Figure 31: Typical lock joint designs. (19)

### 13.1.5 Adhesive bonding

Adhesive bonding involves the use of an adhesive to hold materials together. Because adhesive bonds can transmit stresses from one member to another more uniformly over a larger area compared to mechanical joints, they are often equivalent to or stronger than conventional assemblies at a lower cost and weight. In order to produce an effective bond, the adhesive must be capable of completely wetting the surfaces of the substrate and produce a strong attractive interaction between the adhesive and substrates. Austenitic stainless steels can be joined using various adhesives including silicone, epoxy, acrylic, and polyurethane.

The choice of adhesive depends on the required strength of the joint and the expected service environment. Advantages and limitations of adhesive bonding are summarized in **Table 26**.

When using adhesive bonding the joint design is very important. It should increase the bonding area and reduce stress concentrations caused by moments and edge effects (see ref. 29 for recommended designs). Substrate surface treatments are required to clean substrate surfaces and maximize bond strength. Surface pretreatments include the use of mechanical, chemical or physical methods to remove strongly adsorbed surface layers and activate the substrate. Some commercially available

adhesive systems also make use of special surface treatments involving primers or other adhesion promoters. Users should check with adhesive manufacturers' recommendations on their use.

## 13.2 Corrosion considerations with mechanical joints

### 13.2.1 Crevice corrosion

The natural crevices of a lock seam or beneath the bolt head, washer, and nut of bolted joints are susceptible to crevice corrosion (see section 6.2.1). In a moist environment some fluid will penetrate even the tightest joint, making most mechanical joints susceptible

Table 26: Advantages and limitations of adhesive bonding.

Advantages	Limitations
Makes a joint almost invisible, enhancing product appearance	Does not permit visual examination of the bond area
Provides uniform distribution of stress and a greater stress-bearing area	May involve long cure times, particularly where low cure temperatures are used
Joins thin and thick material of any shape	Requires careful surface preparation, often with corrosive chemicals
Joins similar and dissimilar materials	May require holding fixtures, presses, ovens and autoclaves not usually needed for other fastening methods
Minimizes or prevents galvanic corrosion between dissimilar materials	Should not be exposed to service temperatures above approximately 180°C/350°F
Resists fatigue and cyclic loads	Requires rigid process control, including emphasis on cleanliness, for most adhesives
Provides joints with smooth contours	Depends, in respect of its useful life, on the environment to which it is exposed
Seals joints against a variety of environments	Must have a relatively snug fit between materials
Insulates against heat transfer and electrical conductance	May change properties with time
Free from heat-induced distortions	May be affected by any chemical or solvent it comes in contact with
Dampens vibrations and absorbs shocks	Chemicals may leach out of the adhesive
Provides attractive strength/weight ratio	
Is frequently faster and cheaper than mechanical fastening	

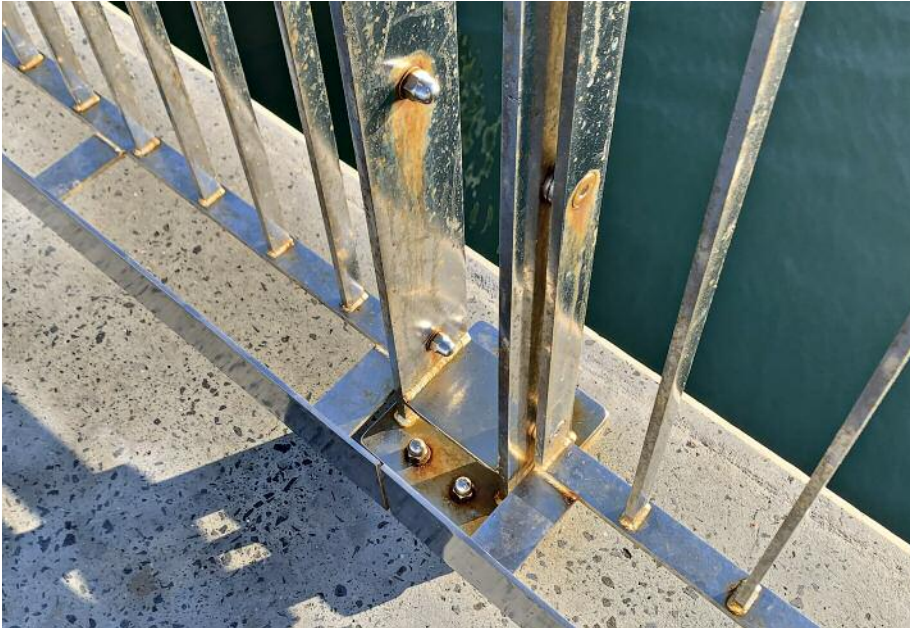

Crevice corrosion at the bolted connections of a hand rail exposed to seawater splashing.  
© Graham Sussex

to crevice corrosion. The likelihood of crevice corrosion increases with increased crevice tightness, certain gasket materials, and severity of the corrosive environment. Normal atmospheric environments usually are not a threat to bolted joints of Type 304. On the other hand, an HPASS bolted joint in a warm seawater environment could present a problem. It is difficult to design against crevice corrosion if the aggressiveness of the environment is close to the joint materials' threshold of corrosion resistance. The most common approaches for avoiding crevice corrosion are to either avoid mechanical joints or choose materials that have sufficient crevice corrosion resistance to resist the environment of interest.

### 13.2.2 Galvanic corrosion

Galvanic corrosion can occur whenever two different metals are electrically connected in a corrosive environment. When two different metals are coupled the more active or less corrosion-resistant alloy will corrode at an accelerated rate, while the more noble or more

corrosion-resistant alloy will tend to be protected (see section 6.4). There are four ways to deal with the galvanic problem in mechanical joints:

- Avoid coupling dissimilar metals in a mechanical joint, for example aluminum fasteners for stainless steel sheets.

- Use insulators to separate the dissimilar metals making up the joint (**Figure 32**).
- If dissimilar metals must be used, select metals that are close together in the galvanic series (see Figure 21 in Section 6.4).
- Adjust surface areas of dissimilar metals so that the metal most likely to corrode (active metal) has a much larger exposed surface area.

The HPASS are relatively noble (corrosion-resistant), so they can cause more active metals such as carbon steel, aluminum, many copper alloys, and depending on the environment less resistant stainless steels to corrode, if used improperly in a joint. However, they are useful as fasteners to join less noble material (e.g. HPASS bolts with Type 316 sheet), because in this case the less noble metal has a much larger surface area than the fastener. The design brochures on the Reading List in the Appendix provide approaches to avoid galvanic corrosion through optimum joint design.

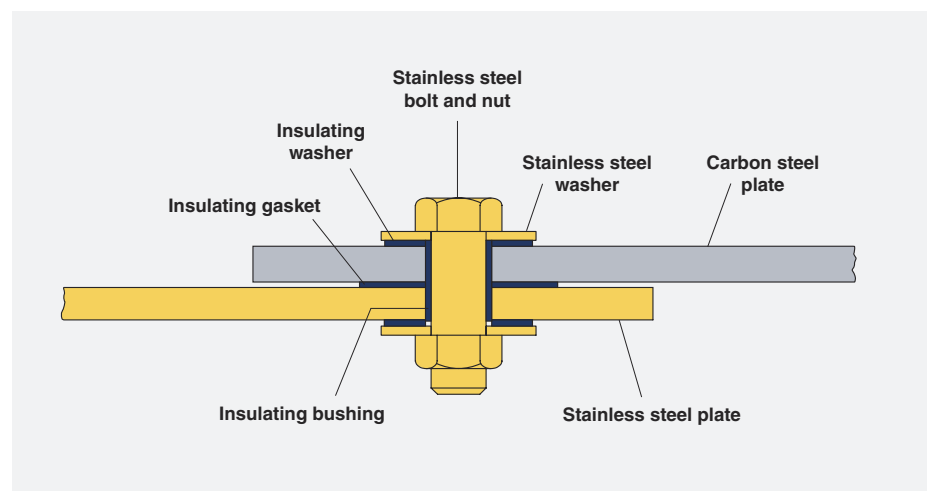

Figure 32: Insulating washers used to prevent galvanic and crevice corrosion in a bolted joint in a water shedding application. (based on 27)

# 14 Surface finishes

The broadest variety of stainless steel finishes are available on the standard austenitic stainless steels, Types 304 and 316. It is easier to achieve a high quality finish on austenitic stainless steels than on other families of stainless steel. Applying finishes to higher alloyed stainless steels is somewhat more expensive because of their greater resistance to acid pickling, grinding and polishing, and the finish options are more limited. It is however easier to apply finishes to high alloyed austenitic stainless steels than it is to ferritic and duplex stainless steels of comparable corrosion resistance.

The specification of surface finishes is an important aspect of design because it affects corrosion resistance, surface deposit accumulation rates, flatness, reflectivity and heat gain in exterior applications, cleanability, and appearance. A wide range of industrial and aesthetic finishes are available. The product form and size of a component determines which finishes are easily produced and readily available. For example, structural sections like tees, I-beams and other structural shapes are typically sold with mill or abrasively-blasted surfaces whereas round hollow sections can be obtained with linearly polished exterior surfaces. When a smooth finish is required on light gauge sheet, the bright annealed (BA or 2R), 2B and 2D mill finishes are cost-effective options but they may not meet aesthetic requirements without further processing. Some special finish options like coloring, mirror polishing, coining, embossing, and specialty mechanical finishes are only readily available on lighter gauge sheet. A finer linear polish or a mirror finish can be obtained on plate, but it is typically substantially more expensive because the starting finish is rougher and each plate must be individually polished as opposed to in-line polishing that can be applied to coiled sheet products.

There are international standards for mill, polished and patterned (coined or embossed) finishes. When these finishes are purchased, it is important to reference the standard. However, the finish requirements in international standards are often broad and can be interpreted differently. If the project requires close finish matching, low or high surface reflectivity, a particular roughness value or some other characteristic that is measurable, then the requirements of the standard should be tightened within the project specification requirements. It is important to note that the standard appearance, processing steps and roughness of mill and linear polished finishes can vary around the world. Obtaining reference samples and quantifying surface characteristics can help to avoid misunderstandings. There are no internationally recognized standards for some special finishes for aesthetic applications so their characteristics should

be defined based on both appearance and measurable characteristics such as acceptable surface roughness, gloss and color range.

The finish of a completed piece reflects its manufacturing history through the steel mill and the fabrication shop. End users often specify a surface finish that meets their design criteria, which can dictate specific surface finishing processes.

## 14.1 Finish and performance

The microscopic surface morphology or texture of a finish can have a strong influence on the corrosion performance, particularly for surfaces exposed to atmospheric conditions. The texture of a mechanically polished surface is determined by the type of abrasive and the finishing technique. For optimum corrosion performance polished surfaces must avoid metal overlaps, which can



Wine tanks often use a fine, circular polished finish, which is hygienic, easy to clean, decorative and hides any dings and scratches. Surface finish requirements are an important part of the design process. © iStock.com/Josef Mohyla





This Type 316 stainless steel bollard is exposed to road-salt splashing from passing cars. The bottom has a rough ground finish and the top a smoother polished finish which causes the performance difference. © IMOA

serve as sites for initiation of crevice corrosion. A new polishing belt cuts the surface cleanly, leaving consistent furrows that look like a newly plowed field under magnification. A badly worn belt, on the other hand, can tear and smear the surface, creating overlapping

areas (i.e. crevices). Several common types of abrasive blasting, like sand and silicon carbide, create deep narrow recessed areas. While rolled-on patterned finishes (i.e. coining and embossing) are typically applied over a very smooth surface, some patterns are easily rain- or manually-washed while others accumulate deposits more readily.

Rougher surfaces accumulate more dirt and corrosive substances and with a higher surface tension, retain moisture longer. Moisture and corrosive substances are needed for corrosion to occur. Corrosion can initiate at lower temperatures and lower chloride salt exposures on surfaces with microscopic crevices than on smooth surfaces without crevices. Two side-by-side components made from the same stainless steel grade can perform very differently simply because of the finish.

As the alloy content of the stainless steel increases, the stainless steel becomes more resistant to corrosion. If the service environment is more severe or a rougher surface finish is used, then a more corrosion-resistant stainless steel should be specified. Many applications

in the architectural, food processing, pharmaceutical, medical, gas handling and other industries require an easily cleaned finish that does not attract or retain foreign matter. Inadequate surface cleanliness can contaminate product and be a health and safety concern. Similarly, surfaces finishes which are more difficult to clean will require more aggressive cleaning regimens and can increase maintenance costs. Specific finishes are often specified for these hygienic applications and high quality smooth finishes are easily applied to the austenitic stainless steels making them ideal construction materials for these more demanding applications.

## 14.2 Steel mill supplied finishes

### 14.2.1 Plate

Plate is a flat-rolled or forged product and, based on ASTM A480/A480M, has a minimum thickness of 4.76 mm (3/16 inch) and a minimum width of 254 mm (10 inches). It is produced as hot rolled or forged slabs or ingots that are then annealed and descaled. The standard mill plate finishes are summarized in **Table 27**.

Table 27: Plate surface finishes from ASTM A480/A480M and EN10088.

ASTM condition and finish	Corresponding EN 10088 finish	Description and remarks
Hot or cold rolled and annealed or heat treated, scale not removed	1C	Specified for high temperature applications or as an intermediate finish. Scale gives the plate a rough, dark, non-uniform appearance and reduced corrosion resistance.
Hot or cold rolled, annealed or heat treated, blast cleaned or pickled	1D (pickled) or 1E (blasted)	Commonly preferred for corrosive and most high temperature applications. Similar to a No. 1 sheet finish.
Hot or cold rolled, annealed or heat treated, and surface cleaned and polished	1G, 1J or 1K	Polished finish is generally a No. 4 finish.
Hot rolled or cold rolled, annealed or heat treated, descaled and temper passed		Smoother plate finish for specialized applications.
Hot or cold rolled, annealed or heat treated, descaled, cold-rolled, annealed or heat treated, descaled and optionally temper passed		Smooth plate finish with fewer surface imperfections compared to the previous finish.

Table 28: Classification of sheet and strip standard mill finishes from ASTM A480/A480M and EN10088.

ASTM Finish No.	Corresponding EN 10088	Description	Corresponding finishing operation
<b>Sheet: Coils and cut lengths under 4.76 mm (3/16 inch) thick and over 610 mm (24 inch) wide</b>			
1	1E	Rough, dull, non-reflective, hot-rolled finish	Hot rolling, annealing and descaling
2D	2D	Smooth, dull, non-reflective, cold-rolled finish	Cold rolling followed by annealing and descaling, may also receive a final light pass through unpolished rolls
2B	2B	Bright cold rolled finish	Same processing as 2D with a final, light pass through polished rolls
BA	2R	Bright annealed finish	Cold rolling followed by inert gas annealing, then cold rolled using highly polished rolls to create a brighter finish than 2B. For a mirror-like finish, buffing should be specified (i.e. buffed 2B)
TR		Cold worked to obtain specific properties	Cold rolling of an annealed and descaled or bright annealed product to obtain higher strength levels than an annealed product. Appearance varies with the starting finish, amount of cold work and alloy
<b>Strip: Cold finished coils and cut lengths between 0.127 and 4.76 mm (0.005 and 3/16 inch) thick and under 610 mm (24 inch) wide</b>			
1	1E	Dull, gray, matte to reflective surface	Cold rolled to specified thickness, annealed and descaled
2	2B	Smoother and more reflective than No. 1	Same process as No. 1 with the addition of a final, light cold roll pass, generally through highly polished rolls.
BA	2R	Bright annealed	A bright, cold rolled finish, obtained by final annealing in a controlled inert gas atmosphere
TR		Cold worked to obtain specific properties	Cold rolling of an annealed and descaled or bright annealed product to obtain higher strength levels than an annealed product. Appearance will vary with the starting finish, amount of cold work and alloy

### 14.2.2 Sheet and strip

Sheet and strip are thinner than plate. They are produced by various process sequences that include hot rolling with or without subsequent cold rolling, annealing or heat treating, and final finishing and cleaning. They can be delivered in coil form or as individual pieces of cut sheet. There are specific process sequences designed to produce both standard finishes and special finishes. **Table 28** describes standard ASTM mill finishes and the corresponding EN finishes are cross-referenced. The most common mill sheet or strip finish is 2B.

### 14.3 Mechanically applied finishes

Linearly and mirror polished finishes are generally obtained by polishing or buffing using abrasives. There are also rolled-on finishes that resemble linearly polished finishes which are an acceptable substitute in some standards. In some parts of the world, the term for linearly polished finishes is “linished”. Numerous factors influence the final appearance, including the final abrasive grit number, belt replacement frequency, abrasive type, use of lubrication (i.e. dry versus wet polishing) and

other processing variables. The No. 3 and 4 finishes are the most widely used polished finishes. The corrosion resistance of mechanically applied finishes can vary widely. The same designated finish, for example a No. 4, from different sources can show a substantially different appearance and resistance to the initiation of localized corrosion. These differences are related to the specific polishing procedures and the type of abrasive used in applying the finish. When corrosion performance is important then the corrosion resistance of polished samples should be evaluated as part of the selection process.

The most common way to quantify finish requirements in project specifications is through finish samples and agreed surface roughness (i.e. Ra) and gloss (i.e. reflectivity) values. However, when matching from multiple suppliers is critical, such as in the appliance industry or when there are stringent reflectivity requirements, additional properties, such as Rz or Ry values or 3D profile analysis

may be specified. Reflectivity is an important property for some applications. For example, exterior surfaces of buildings must generally avoid highly reflective finishes because of the potential for blinding glare. The reflectivity is determined by texture and directionality of the surface finish and it should not be assumed that smoother finishes are more reflective.

Polishers often try to distinguish their product's appearance from their competitors' so it should not be assumed that the same specified finish from different suppliers will have exactly the same appearance. **Table 29** summarizes common ASTM and EN polished finishes.

Table 29: ASTM A480 and EN 10088 polished sheet surface finish comparisons.<sup>1</sup>

ASTM Finish	EN 10088 finish	Description ASTM	Description EN 10088	Explanation ASTM <sup>2</sup>	Explanation EN 10088 <sup>2</sup>
	2G		Ground finish	No ASTM equivalent	Grit or surface roughness can be specified. Unidirectional texture, not very reflective
No. 3	2J	Intermediate finish, one or both sides	Brushed or dull polished	A linearly textured finish that may be produced by either mechanical polishing or cold rolling. The average surface roughness (Ra) may be up to 1.0 µm (40 µin) but this is not a mandated limit. ASTM No. 3 and No. 4 are often dual certified.	Will be smoother than a ground finish. Grade of brush, polishing belt or surface roughness can be specified. Unidirectional texture, not very reflective. Typical Ra 0.2–1.0 µm (8–40 µin)
No. 4	2K	General purpose polished finish, one or both sides	Satin polished	A linearly textured finish that may be produced by either mechanical polishing or rolling. The average surface roughness (Ra) may be up to 0.64 µm (25 µin) but this is not a mandated limit. ASTM No. 3 and No. 4 are often dual certified.	Smoothest of the non-reflective finishes. Transverse Ra less than 0.5µm (20 µin) with clean cut finish
No. 6		Dull satin finish, Tampico brushed, one or both sides		This is normally applied over a No. 4 polish and has a soft satin appearance. Tampico plant brushes, oil and abrasives are used.	No EN 10088 equivalent
No. 7	2P	High luster finish	Bright polished	A high luster of reflectivity achieved by buffing a finely ground surface, but the grit lines are not removed.	Non-directional mechanically polished and buffed finish, reflective with high degree of image clarity. Process or surface roughness can be specified.
No. 8	2P	Mirror finish	Bright polished	A highly reflective, smooth finish, typically produced by polishing with successively finer grit abrasives, then buffing. Very faint polish lines may still be visible on the final product.	Non-directional mechanically polished and buffed finish, reflective with high degree of image clarity. Process or surface roughness can be specified.

1 These finishes are similar but not identical in their requirements

2 The explanations are intended to provide a more in-depth understanding of the typical product but are not requirements

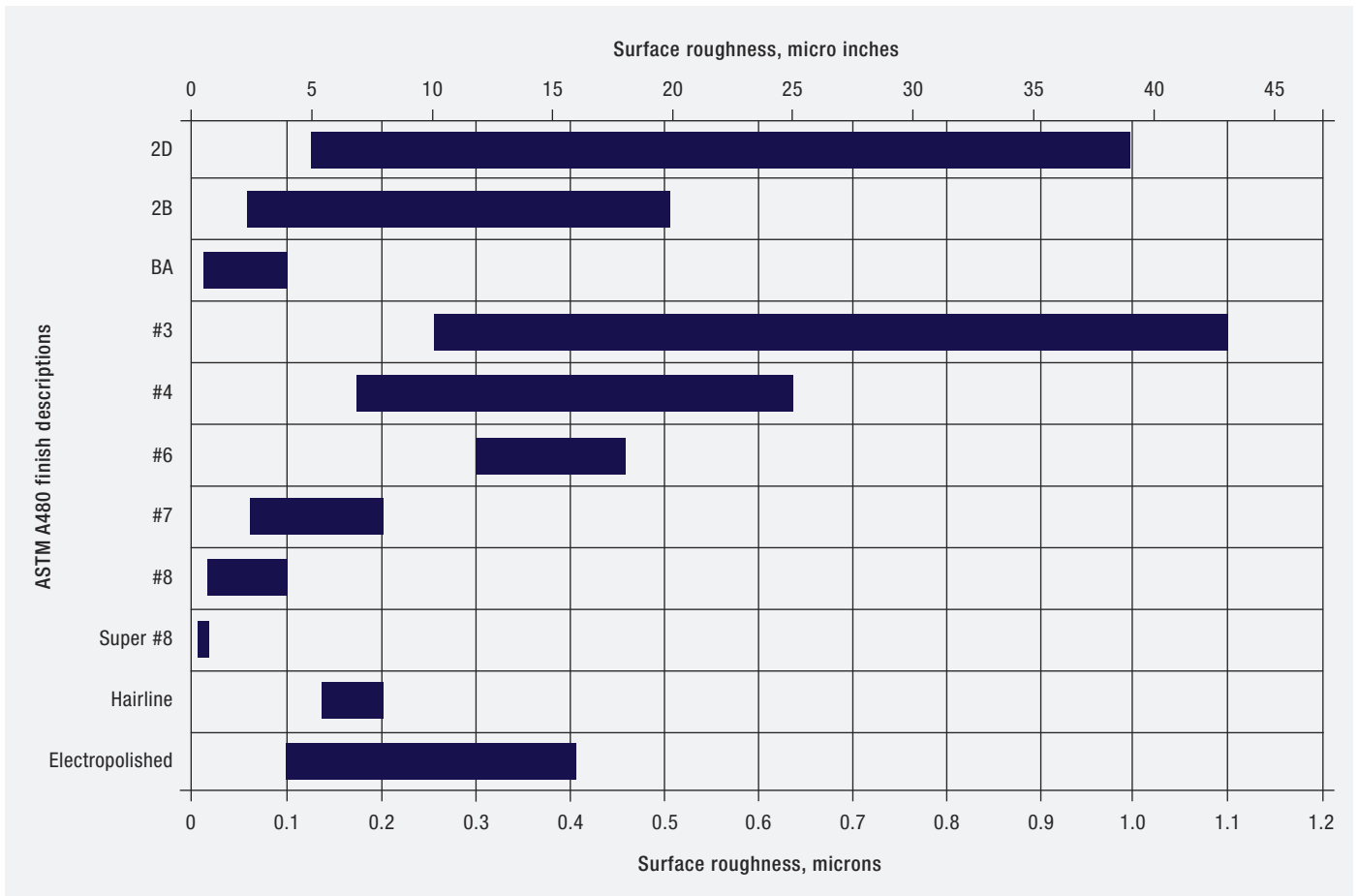

Figure 33: Typical average surface roughness (Ra) ranges for stainless steel sheet from North American and European suppliers. (30)

Note: The highest and lowest values reported during the survey were used to create the surface roughness range and include both light and heavy gauges. Lighter gauges generally have smoother finishes than heavier gauges and would be at the bottom end of the range. Surface roughness will vary across sheet width and length.

When surface roughness is important to product performance, for example in corrosive environments, a maximum value should be specified and parameters like wet polishing and frequent belt replacement should be discussed with the supplier. **Figure 33** and Table 29 summarize typical average surface roughness (Ra) ranges for polished and mill finishes.

If a uniform surface finish is desired, and the production of the part involves steps that affect the surface finish like welding or bending, it is best to

specify an initial polished finish. The part can be fabricated with most of the surface finish protected by an adhesive plastic film. The areas affected by fabrication can then be blended with the initial finish by successive grinding and polishing during installation.

#### 14.3.1 Specialized mechanical finishes

A wide range of customized mechanical finishes are available from fine, smooth, non-directional vibration patterns to rough, coarsely ground finishes. They can be applied by hand for small projects,

but the most consistent and uniform results are achieved on individual sheets with special computer-controlled programmable set-ups. For coarser patterns, the back of the panel should also be abraded to prevent the panel from warping due to uneven surface stresses.

Coarse patterns include ground circles, non-directional patterns that hide minor damage from vandalism and elaborate decorative designs. The coarser ground patterns will accumulate more dirt and deposits, which needs to be considered during design and material selection.



Buffing adds luster to a stainless steel surface.  
© Magic Disc

Very fine, non-directional finishes, for example vibration finishes, can perform as well as fine directional polishes in more corrosive environments.

### 14.3.2 Buffing

When discussing buffing, it is important to understand the terms used for the two types of motions “cut” and “color”. “Cut” refers to moving the workpiece against the rotation of the buffing wheel using a medium or high pressure. A more aggressive abrasive is used to remove metal and the process produces a uniform, smooth, semi-bright surface finish while eliminating the remaining scratches and other imperfections. “Color” refers to moving the workpiece with the rotation of the buffing wheel using medium to light pressure and a finer, less aggressive abrasive, which produces a bright, shiny surface finish.

The most consistent blemish-free buffed finish is achieved on low sulfur austenitic stainless steels (i.e. a sulfur content of 0.002% or less by weight). If the stainless steel does not have a low sulfur level, then the final mirror-like surface can have tiny indentations, where sulfides were pulled from the surface.

The highest quality buffed finishes are achieved by grinding to remove surface defects and then linearly polishing with a series of gradually finer abrasive belts.

Wet linear polishing with a fine grit belt is the final step before buffing to produce a smooth starting surface. There are two buffed ASTM A480 finishes. A No. 7 finish has enough buffing to further smooth the finish, but fine polishing lines are still evident. A No. 8 ASTM finish has more buffing, and the remnants of fine polishing lines are only evident when a sample is examined closely.

For some applications, mill finishes can be buffed to achieve a mirror-like appearance at a lower cost. The typical specification is a “buffed bright annealed” (ASTM BA or European 2R designation) mill finish. However, the buffing of a mill finish may not remove all surface imperfections. Because of this, buffed mill finishes are used when there are no stringent sanitation requirements or for small or elevated aesthetic surfaces, where smaller defects are less visible.

### 14.3.3 Abrasives for mechanical finishing

Polishing starts with coarser abrasives to remove rough scratches and imperfections, and continues with progressively finer abrasives to create

a smooth surface. The type of abrasive used determines cutting efficiency and cost. It is very important to work with the correct speed for each grit and abrasive type. Excessive speed can produce heat build-up that may cause distortion and yellowing of the finished surface due to oxidation. Abrasive producers publish tables and charts that can help the user to determine the correct abrasives and speeds for specific jobs. The following sections give an overview of the available abrasive types. Adding polishing lubricants (i.e wet polishing) can produce more cleanly cut surfaces.

#### 14.3.3.1 Coated abrasives

Coated abrasives (e.g. sand paper) employ abrasive particles embedded in a sheet of paper, cloth, or some other material. Abrasives are typically manufactured using abrasive minerals, including oxides of aluminum (alumina), silicon (silica) or zirconium (zirconia). Alumina is brown, whereas zirconia is blue or green.

Coated abrasive products come in various sizes, shapes, and grit numbers. The term “grit” expresses the roughness of the abrasive, and is related to the



Manual polishing of a stainless steel pipe to blend the fabrication weld with the pipe surface finish.  
© Olya Humeniuk/Shutterstock.com

particle size of the abrasive used in the sheet. Larger particles remove material more aggressively than smaller particles. Grit numbers vary from no. 36 up to 600, with particle size decreasing as the grit number increases. When polishing to a progressively finer surface finish, one does not have to move progressively through every grit number. The rule of thumb is to move to a grit number no more than twice the previous number. For example, when working with grit 40, one should not go higher than grit 80 for the next pass.

When the polishing applications allow, it is good practice to alternate the polishing direction when changing grit numbers, so that each pass is perpendicular to the previous one. This way, the abrasive will not cut deeper and deeper but the differences between the peaks and valleys on the surface become shallower. This technique also allows the operator to know when all of the grinding marks from the previous operation have been removed. If this is not accomplished, marks can remain after polishing and cause appearance variations.

#### 14.3.3.2 Non-woven products

Non-woven products are made of nylon fibers soaked with an abrasive whose grit number determines the “roughness” of the product. Unlike coated abrasives, non-woven products do not remove much material from the workpiece. They merely smooth the peaks and valleys in the surface. Consequently, their nomenclature is not like that of coated abrasives where grit numbers are used. Instead, the fineness is expressed as “coarse”, “medium”, “fine”, “very fine”, or “super fine”.

#### 14.3.3.3 Buffing pastes

Polishing compounds can be in liquid or solid form. The appropriate buffing compound is determined by the strength and hardness of the material to be buffed. The proprietary compounds developed by specific manufacturers have a shelf life that is determined by the binder. Buffing wheels or “mops” are

typically made from cotton or wool cloth and there are many types. The optimal combination of buffing wheel and compound depends on the buffing phase and manufacturers recommendations. For large scale industrial buffing of stainless steel, a black compound (emery abrasive) is common for rougher buffing where more metal removal is required (cut). Green compounds (chromium oxide or aluminum oxide) were developed exclusively for the final “cut” and “color” buffing of stainless steel. There are other minerals that are sometimes used to polish stainless steel but red (iron oxide) jeweler’s rouge should never be used.

### 14.4 Coined and embossed finishes

Coined and embossed finishes are also referred to as patterned finishes, because a pattern is pressed into the sheet surface in a rolling operation. When the pattern is one-sided and created with one patterned and one smooth roll it is called “coined”. Coined finishes include dull-textured, low reflectivity roof finishes, patterns that look like mechanical polishing, which are used on some appliances, and popular curtain wall patterns like linen. These light patterns effectively diffuse light which minimizes glare and makes panels look flatter, for example in architectural applications. When both rolls are textured to create a two-sided pattern, it is called “embossing”. Embossed patterns include corrugation, tread, chequer or diamond for floor plates and smaller, very consistent patterns like dimples and tear drops. They are used for applications like conveyor belts, slip-resistant durable flooring and stairs, impact-resistant wall panels in public areas, and bathroom partitions. Pressing a pattern into an austenitic stainless steel increases its strength making it stiffer and more scratch- and impact-resistant.

International standards should be referenced when ordering these finishes. ASTM A793 is the standard

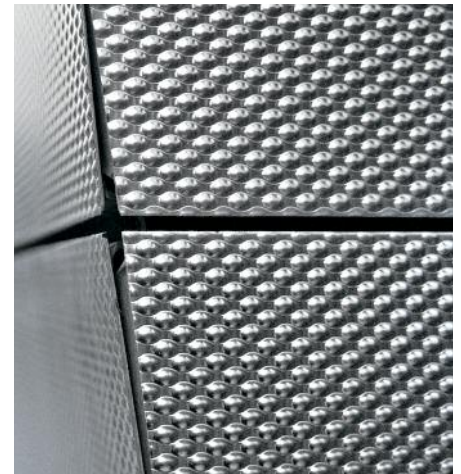

Embossed stainless steel panels.  
© Martina Helzel

specification for stainless steel floor plate. ASTM A947M is the standard for textured stainless steel sheet. The European standard EN 10088 includes corrugated (2W finish) and patterned (1M is floor plate and 2M is for lighter embossed or coined) finishes.

When formed into tubes and laser welded, these finishes are popular for slip resistant railings, posts and grab bars in public transit, care facilities and parks. The small weld line is visible along one side.

### 14.5 Colored stainless steel

There are three primary means of coloring stainless steel surfaces. Stainless steel can be painted with standard metal paints and primers or enameled, but the passive film must be removed within, at most, a few hours before priming to achieve proper paint adhesion. The passive film is removed chemically with an activating solution or alternatively, an appropriate etchant primer can be used. As with all paints, the coating will eventually deteriorate; however the corrosion resistance of a stainless steel substrate often extends its life relative to less corrosion-resistant metals.



Electrochemically colored stainless steel fins (except orange) on the Doppler Building in Seattle. © IMO A

Electrochemical coloring of stainless steel is similar to coloring aluminum or titanium. All of these techniques use electrochemistry to thicken the passive films on these metals giving them the appearance of color. While the finish performs as well as a well-passivated surface, any corrosion will result in color change. Therefore, alloy selection should be conservative or regular

cleaning planned in environments with corrosive salts or pollution. This finish can be easily scratched and damaged, but it will not fade due to UV exposure. It has been used for roofs and curtain walls that have provided over 40 years of service without noticeable color change. A wide range of colors are available, and the process can be applied over any finish. Coined and colored finishes are

especially popular. The underlying finish will be visible through the translucent color and when the finish is viewed from different angles its appearance will change.

Physical Vapor Deposition (PVD) or sputtering can be used to apply a very thin ceramic coating to the surface. A wide range of colors is available. These finishes are opaque, but the texture of the underlying finish affects their gloss. They are more scratch-resistant and consistent in color than electrochemically colored finishes. However, they are porous and if they are not properly applied they can flake off, be inconsistent in color and have crevice corrosion problems. Supplier vetting and testing of the product is suggested.

Other chemical coloring methods have been used on stainless steel but most are less durable than the methods above. Testing the durability of a coloring method is suggested for any high-traffic interior or exterior environment and for those with wind-blown abrasives.

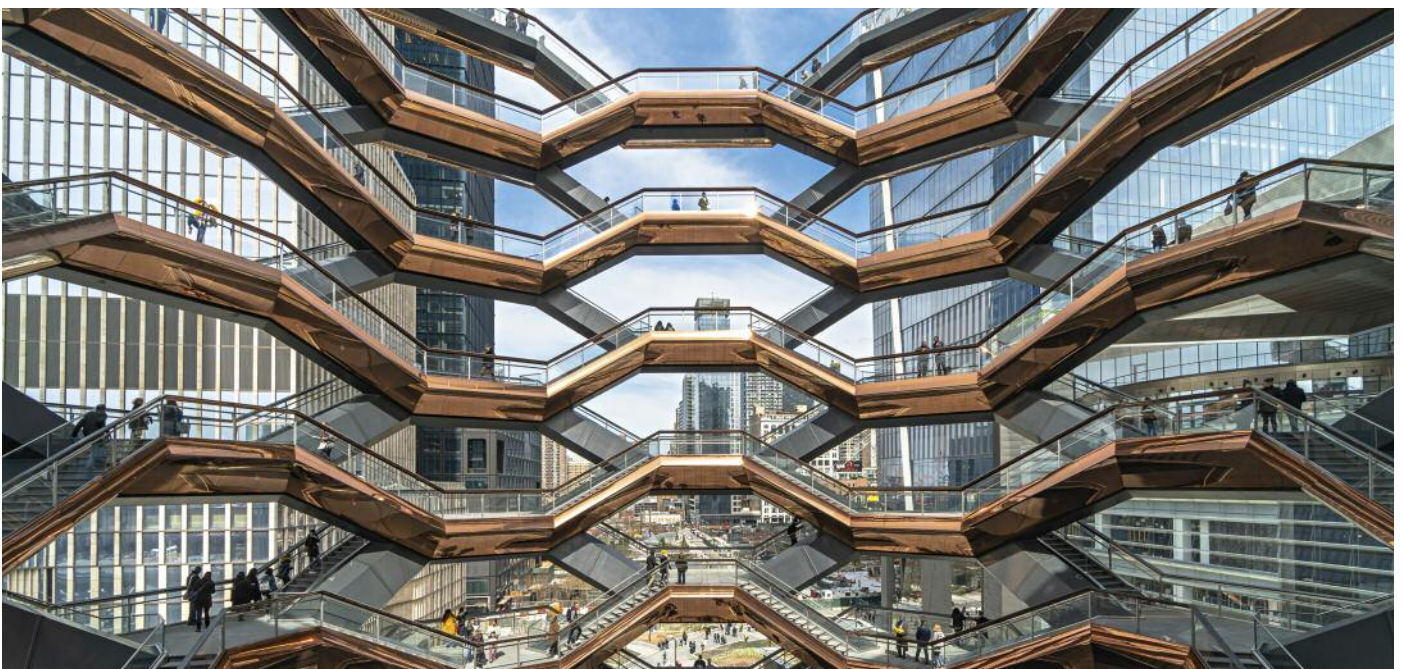

PVD colored stainless steel is used for The Vessel in New York City. © Shutterstock.com/TZIDO SUN

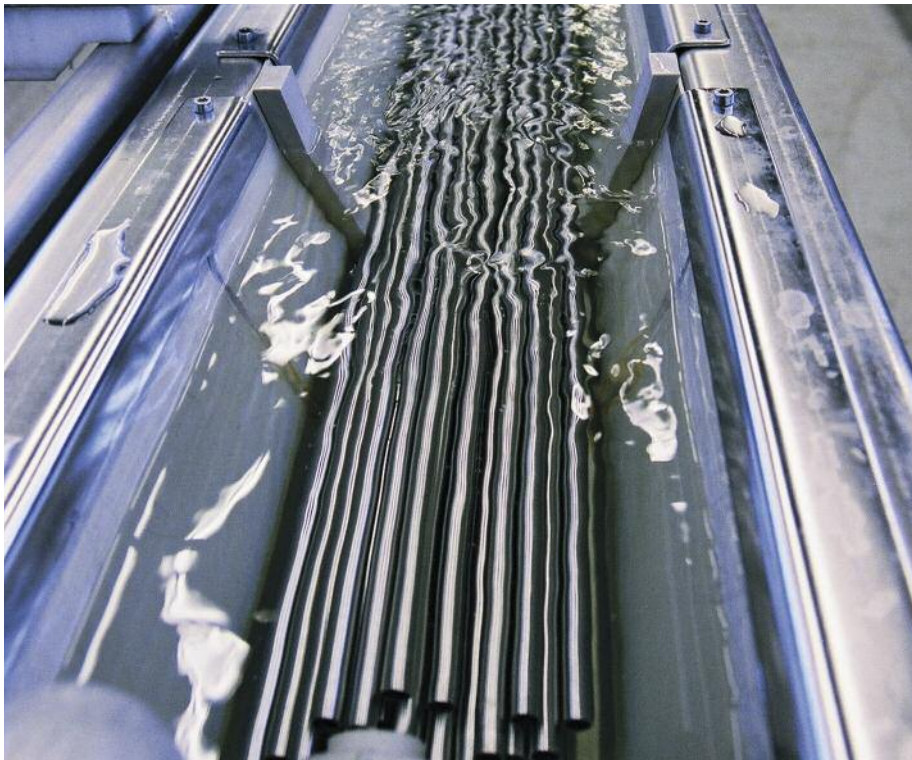

Electropolishing of stainless steel tubes. © Sandvik

## 14.6 Electropolishing

Electropolishing (EP) is an electrochemical polishing method that involves the passing of a galvanic current between the metal work surface and an inert cathode in the presence of a special polishing electrolyte. The electropolishing process smooths and levels the surface, resulting in a highly reflective mirror-like finish. Typically, electropolishing is performed on surfaces that have been previously mechanically polished to a very smooth finish.

Electropolishing can be performed either by immersing the workpiece into a large bath of polishing solution and applying the required anodic current or it can be done locally with hand-held cathodes that are covered with an absorbent pad saturated with polishing solution. Electropolishing typically results in the removal of surface imperfections

and renders a very smooth and passive surface with superior corrosion resistance to other finishes. Because of the improved corrosion resistance and cleanability, electropolishing is often specified for process equipment in the food, pharmaceutical, medical, and semi-conductor industries. Standards that address electropolishing of stainless steels include:

- ISO 15730:2000, Metallic and other inorganic coatings – Electropolishing as a means of smoothing and passivating stainless steel
- ASTM B912, Standard Specification for Passivation of Stainless Steels Using Electropolishing
- SEMI F19, Specification for the Surface Condition of the Wetted Surfaces of Stainless Steel Components

## 14.7 Restoring and protecting the finish after fabrication

Most fabrication operations and even simple handling can scratch and damage the surface finish of stainless steel. Blending can remove these discontinuities and produce a uniform look on parts with a polished surface finish. The blending of a weld or other surface defect follows the same steps as producing a polished surface finish, described above. First, the weld bead and discoloration are removed. This can be done with a rough grinding disc, a flap disc, or an abrasive belt, according to the geometry or the workpiece. Then, the relatively roughly ground surface is polished with successively finer grit until it is smooth and matches the appearance of the surrounding area. It can be difficult to completely hide a weld.

Stainless steel can be ordered with a protective adhesive film, which can be left on the surface during most fabrication operations. If localized heating is involved, the film should be removed from the heated area. Only when the piece is ready to install, or after it has been installed, should the whole film be removed. In this way, most of the surface finish is protected and restorative finishing work is minimized. Not all films are suitable for outdoor (UV) exposure, and may deteriorate with time causing problems when it is time to remove them.



# 15 Post-fabrication cleanup

Stainless steel surfaces should be clean, smooth, and free from heavy surface oxides and contaminants. Fabrication steps such as machining or welding can alter the surface and degrade corrosion resistance. They can contaminate the surface with free iron, oxides and other deposits; they can damage the passive film through chromium depletion; and they can impart mechanical damage such as rough grinding marks (see **Figure 34** for some examples of surface damage, created during fabrication). Therefore, after fabrication, components must be cleaned and corrosion resistance restored by appropriate post-fabrication remediation techniques. The following sections discuss common forms of surface damage and remediation techniques.

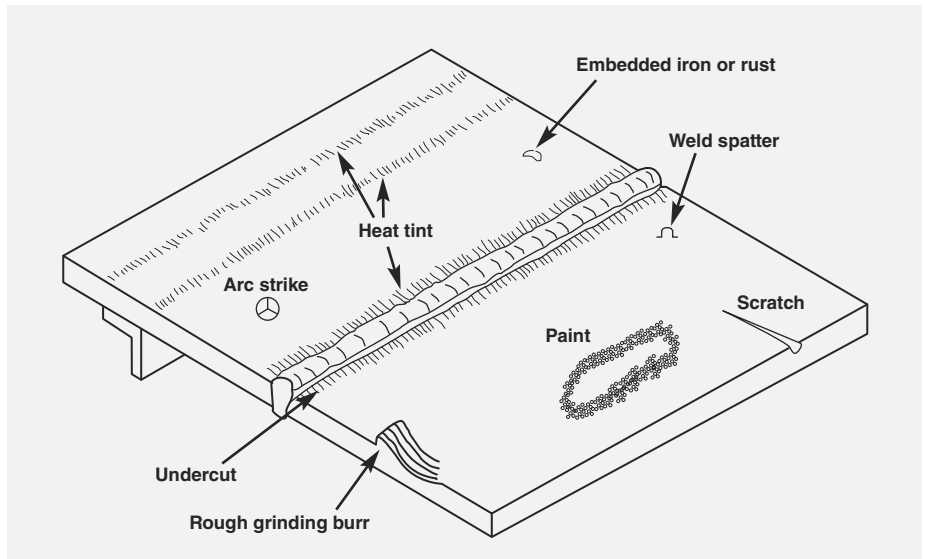

Figure 34: Surface damage and contamination can occur in fabrication. (5)

## 15.1 Common forms of damage and surface contamination

### 15.1.1 Iron contamination

Iron contamination is possible whenever stainless steel comes in contact with carbon steel. It is a common concern because all fabrication shops use carbon steel tools and fixtures. Iron particles deposited on the stainless steel surface will corrode and form rust stains in a moist environment. The picture on the right shows a common example of the inappropriate contact of carbon steel on a stainless steel surface. The presence of rust can also cause corrosion of the stainless steel itself, if the stainless steel is only marginally corrosion resistant in the application environment. HPASS alloys are not immune to this effect, although it is not as severe as for standard grades. **Figure 35** illustrates this point, comparing the effect of several types of iron contamination on corrosion resistance of Type 316 and a 6% Mo stainless steel.

Common sources of iron contamination in the fabricating shop are:

- Carbon steel dust from grinding operations in close proximity to stainless steel
- Carbon steel tools, or the use of equipment or tooling that was previously used on carbon steel
- Grinding wheels previously used on carbon steel
- Steel shot blast media
- Grit blast abrasive previously used on carbon steel
- Carbon steel clamps and transport hooks and chains.
- Forming rolls, presses, and dies used to fabricate carbon steel
- Steel brushes and steel wool
- Any other physical contact between carbon steel and stainless steel



Carbon steel wire brushes used to clean stainless steel welds can produce discoloration and rust. © Outokumpu Stainless

### 15.1.2 Organic compound contamination

Organic compounds include forming lubricants, oil-based coolants, crayon marks and dirt. These contaminants can create a crevice on the stainless steel surface and initiate crevice corrosion in some service environments. They can

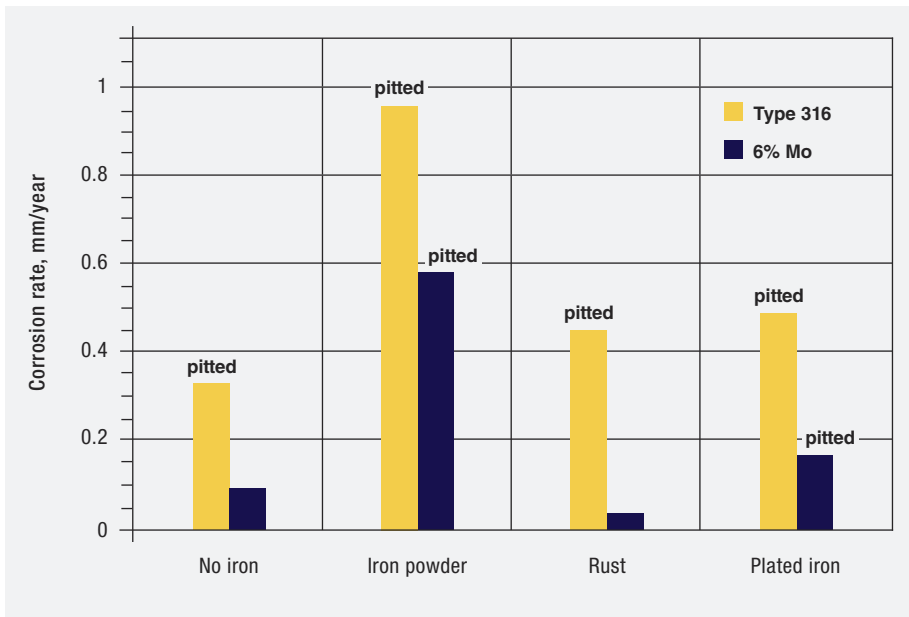

Figure 35: Effect of various types of iron contamination on the pitting resistance of Type 316 and a 6% Mo stainless steel. Samples exposed for 24 hours to an aqueous solution containing 3% CaCl<sub>2</sub>, 3% NaCl, 0.5% FeCl<sub>3</sub>, and aerated with 80% air/20% SO<sub>2</sub>. (31)

than annealing scale. Oxidation can be minimized by welding with a low-oxygen containing shielding gas or by annealing in protective furnace atmospheres, but even with the best of care, it is difficult to completely avoid discoloration. Any visual evidence of oxide formation usually indicates cleaning is necessary for optimum corrosion resistance.

The stainless steel underneath an oxide layer has lower corrosion resistance than the base material. The reason is that chromium preferentially moves from the stainless steel surface into the oxide during its formation and growth, leaving the stainless steel immediately beneath the oxide depleted in chromium. **Figure 36** shows the chromium composition profile across a layer of weld discoloration and the underlying stainless steel. The minimum chromium content just below the oxide can reach levels below the 10.5% required to make a ferrous alloy a stainless steel. Hence, both the scale and the chromium-depleted metal must be removed during post-fabrication cleanup to completely restore corrosion resistance.

### 15.1.4 Other defects

Welding defects (undercuts, spatter, and craters) cause crevices that lead to corrosion. Scratches, gouges and

also shield previously embedded iron or weld oxide and prevent pickling or passivation acids from reaching the metal surface, inhibiting the cleaning and passivation of the stainless steel. Furthermore, if not removed, organic compounds can carburize the stainless steel surface upon subsequent heating operations such as welding or heat treatment.

clean stainless steel surface. Moving from thinner to thicker layers, oxide color ranges from a transparent light straw to deep blue and opaque black. Scale color and thickness depend on exposure temperature and time, with higher temperature and longer time promoting layer growth. For example, welding scale is normally thinner and lighter in color

### 15.1.3 Oxide scale formed during annealing and welding

In the presence of oxygen, stainless steels form an oxide scale when exposed to high temperatures during annealing, stress relieving or welding. The oxide forms both during heating in air and in oxidizing furnace atmospheres. The oxides formed at these higher temperatures are not effective barriers to aqueous corrosion and their presence typically lowers the corrosion resistance. These oxides are porous and much thicker than the normal protective passive layer that forms at lower temperatures on a

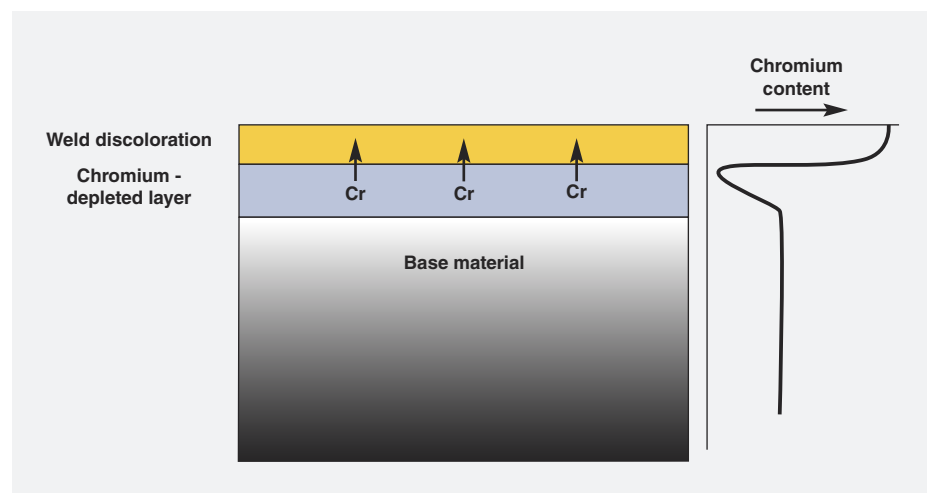

Figure 36: Schematic of the chromium concentration across an oxide scaled surface.

extreme roughness can result in micro crevices and highly deformed surfaces that can accumulate and hold aggressive contaminants. If not removed these defects can serve as the initiation site for localized corrosion. Surface contamination by low-melting metals like copper can cause liquid metal embrittlement, a type of intergranular attack, upon subsequent heating.

## 15.2 Post-fabrication cleanup methods

Many mechanical and chemical methods are available for post-fabrication cleanup. The appropriate method depends on the nature and

severity of the contamination and the intended use of the stainless steel. The best possible method always involves a final acid treatment that restores passivity and corrosion resistance. **Table 30** summarizes common methods and provides a short discussion of each.

### 15.2.1 Sandblasting

Sandblasting can clean large, heavily scaled areas cost-effectively. The sand should be clean, and not previously used on carbon steel. It can easily embed contaminants like dirt or iron particles, so a final passivation or in cases of severe embedded contaminants, a pickling step after sand blasting is necessary to impart optimum corrosion resistance.

### 15.2.2 Glass bead blasting

Glass bead blasting is preferred to sand blasting because it leaves a relatively smooth surface. Initial cleanliness is important in this process. It also requires a final passivation or in case of severe embedded contaminants, a pickling step.

### 15.2.3 Grinding and polishing

Coarse grit grinding removes deep defects like weld undercuts and deep scratches. The grinding wheel or belt must be new, or previously used only on stainless steel. Grinding should not heat the surface to the point where a yellow oxide layer forms. Coarse grinding must be followed by grinding

Table 30: Post-fabrication cleanup methods.

Defect or contamination	Cleaning method	Comment
Oil, cutting fluid, organic compounds	Solvent Hot steam High pressure water Caustic cleansers	Remove organic compounds before pickling or passivating and before any high temperature exposure, such as welding.
Iron and steel	Passivation	Passivation must be aggressive enough to remove iron contamination. Pickling may be necessary if large quantities of embedded iron are present.
	Pickling Electropolishing Fine grinding	If pickling is planned, passivation is normally not necessary. Grinding operations should be followed by pickling or passivation to ensure all iron is removed.
Paint	Glass bead blasting or solvent	Use clean grit.
Annealing scale	Sand or glass bead blasting followed by pickling and/or passivation	Use clean grit.
Undercuts Rough grinding marks Scratches Weld spatter	Fine grinding	Use only clean, uncontaminated media. Do not use coarse grinding as a finishing technique; finish with fine grit to smooth the surface.
Weld discoloration	Grinding/polishing Pickling Blasting Electropolishing Brushing	A combination of grinding and pickling is the most effective method to restore corrosion resistance. If brushing is used it should be followed by pickling or electropolishing to fully restore the corrosion resistance.

with successively finer grit, finishing in the 180–220 grit range to produce a smooth surface having good corrosion resistance. Post-grind passivation provides even better corrosion resistance.

### 15.2.4 Stainless steel wire brush/ stainless steel wool

A stainless steel wire brush or stainless steel wool can remove superficial heat tint, surface contamination and dirt. They will not remove a chromium-depleted layer. Subsequent acid pickling is required to restore full corrosion resistance of a lightly oxidized surface cleaned by brushing or steel wool.

### 15.2.5 Degreasing

The presence of organic contaminants like cutting oils, drawing lubricants or

crayon marks can reduce the corrosion resistance and lead to corrosion. They will also prevent a stainless steel surface from being wetted during pickling or passivation with acids. These contaminants must therefore be removed with a caustic cleaner or non-chlorinated solvent prior to customer use or before chemical cleaning treatment.

### 15.2.6 Acid pickling

Pickling creates a very corrosion-resistant surface. It uses strong acids that remove oxide scale as well as the underlying chromium-depleted layer. Since pickling dissolves the stainless steel surface, it must be carefully controlled to avoid over etching the surface. It produces clean surfaces with a dull grey, matte finish that are well passivated.

There are many pickling acid solutions. They usually contain low levels of nitric, hydrofluoric and sulfuric acids, either individually or in various mixtures. The optimum solution chemistry, bath temperature and immersion time depend on the specific stainless steel alloy, the scale thickness, the degree of pre-treatment by blasting or other techniques and the stainless steel alloy.

Pickling rates vary greatly depending on the alloy. For example, the pickling parameters used on Types 304 and 316 stainless steels will not be adequate for more corrosion-resistant alloys like 6% Mo HPASS. **Figure 37** shows that the metal removal rates for various stainless steels in a nitric/hydrofluoric acid pickling bath depend strongly on their alloy content (note the logarithmic scale for the removal rate). This plot demonstrates

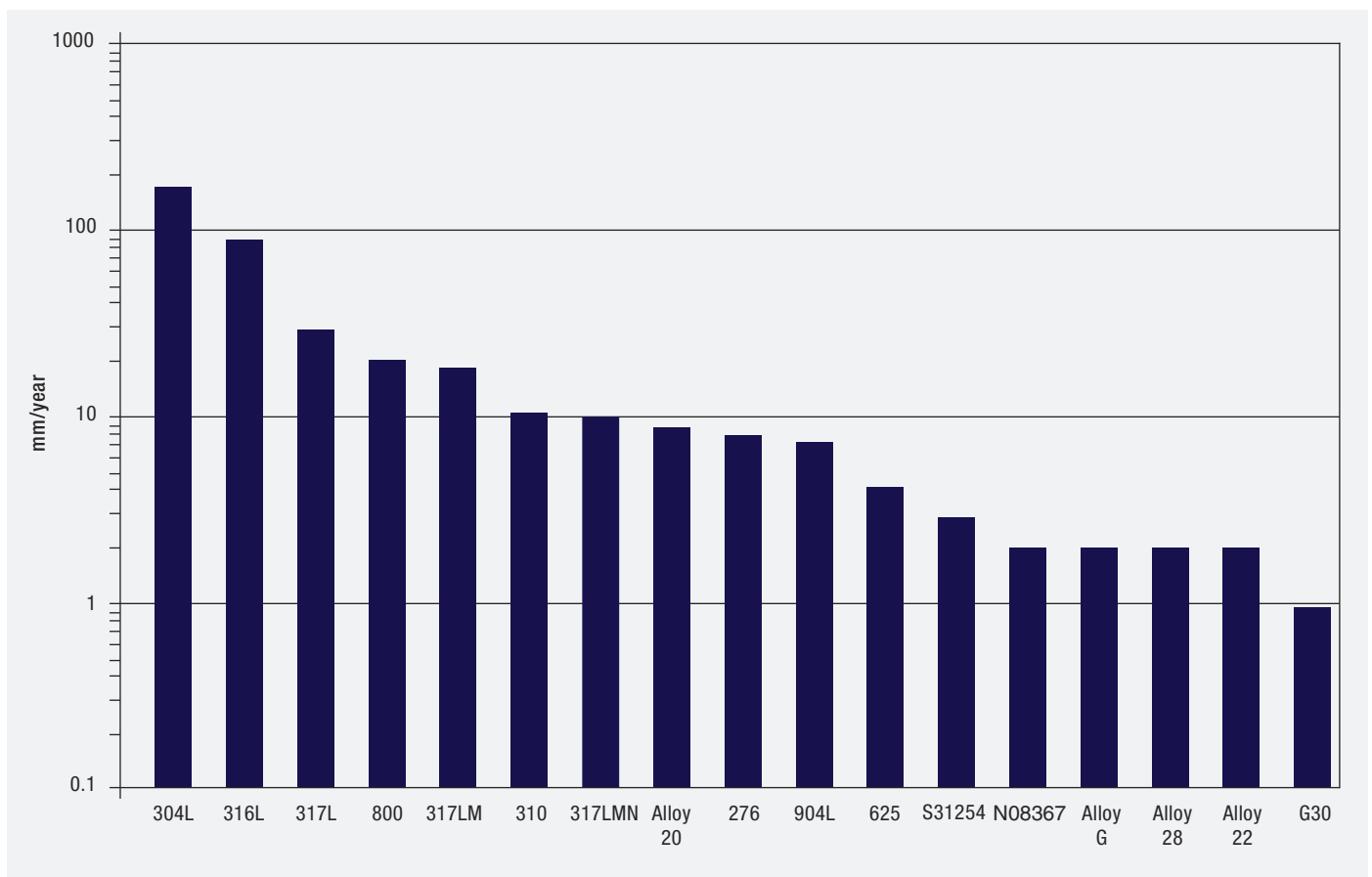

Figure 37: Metal removal rates of stainless steels and nickel base alloys in a simulated pickling solution, (10% HNO<sub>3</sub> + 3% HF) at 21°C (70°F). (32)



Post-fabrication cleanup of welded part: left: as welded, middle: pickled, right: electropolished. © Calamo AB

that pickling times for the more highly alloyed austenitic stainless steels will be substantially longer than those for the standard grades. Grit blasting before-hand reduces pickling time to reasonable levels in most instances. If more rapid scale removal is desired with the more highly alloyed stainless steels, molten salt bath descaling can be used.

Pickling procedures which do not use mechanical pre-treatment, must first degrease the surface to assure that the pickling agent can readily reach the stainless steel surface to remove scale and chromium-depleted layer.

Pickling can be performed by immersing the part in a bath or by spraying the pickling solution on the part. Proprietary pickling products can also be applied locally in spray, gel or paste forms. Pickling pastes can be applied by brush either to an entire part or on a limited area – for example, only on the weldment.

After pickling, the component must be thoroughly rinsed in a solution that neutralizes any pickling acid that might be retained on the surface, and rinsed in clean, low-chloride water. After rinsing, it can be air-dried. Tests are available to determine if the surface is free of acid and chloride ion after final rinsing.

Spent pickling and rinse solutions should be disposed of according to applicable

waste disposal requirements. It is important to read and comply with all safety instructions (e.g. use of safety goggles, gloves and other protective gear). Hydrofluoric acid presents special dangers because of its ability to penetrate the skin and remain in the body. It can cause severe long-term damage and even death. Complying with all proper safety and environmental precautions for pickling cannot be overemphasized.

### 15.2.7 Passivation

Passivation is used to remove light iron contamination from the surface of stainless steel. It is less aggressive than pickling, and therefore does not remove oxide scale or the chromium-depleted layer. An acid passivation process produces a protective passive film and also results in a stainless steel surface that can readily re-passivate spontaneously upon exposure to air. It is a very effective way to assure the complete cleaning of stainless steel that has not been pickled. After pre-cleaning with a proper blasting, grinding or brushing procedure, an acid passivation treatment helps assure the complete removal of iron from surfaces.

ASTM standards A967 and A380 provide information on passivation treatments for a variety of stainless steels. Some commercial passivation products are

also available. Nitric acid passivation treatments generally utilize an aqueous solution of 20 to 45 volume percent nitric acid. The parts are immersed for about 30 minutes at temperatures around 20°C to 30°C (70°F to 90°F), then rinsed in water. Citric acid treatments can also be very effective at passivating stainless steels and are often preferred for applications where the use of nitric acid may present safety or environmental concerns. Ammoniated citric acid treatments typically are superior in removing surface iron contamination. Surfaces must first be degreased to assure that the passivation agent can reach the stainless steel surface and remove any iron.

### 15.2.8 Electropolishing

Electropolishing is an electrochemical process that removes embedded iron, welding heat tint and non-metallic inclusions. It smooths the surface and leaves a shiny appearance. It is often a finishing operation in applications where extreme cleanliness and hygiene are important. An electropolished surface is easier to inspect and more easily cleaned because contaminants do not readily attach to the smooth surface. These attributes make it a preferred finishing process for components used in pharmaceutical, semiconductor gas handling and food and beverage applications.

Table 31: Summary of post-fabrication cleaning treatments.

Defect or contamination	Chemical treatments				Mechanical treatments		
	Degrease	Pickle	Electropolish	Passivation	Blasting	Wire brush	Grinding/polishing
Grease and oil	E	N	N	N	N	N	N
Weld heat tint	N	E	E	N	E	(E)1	E
Weld chromium depleted zone	N	E	(E)2	N	N	N	(E)3
Weld slag	N	E	(E)	N	(E)3	(E)	E
Light surface iron contamination	N	E	E	E	(E)4	(E)4	(E)4
Embedded iron contamination	N	E	(E)	(E)	(E)4	N	(E)4
Surface weld defects, mechanical scratches	N	N	N	N	N	N	E

E = Effective  
 (E) = May be effective  
 N = Not effective

1 = Will only remove weld discoloration  
 2 = Since this zone is not visible, it is not easy to know if the zone has been removed  
 3 = Difficult in tight corners, etc  
 4 = Iron contamination tends to smear

### 15.3 Influence of cleaning method on corrosion resistance

The choice of a post-fabrication cleaning method can have a significant effect on the resulting corrosion resistance. Abrasive pad cleaning, stainless steel wire brushing and rough grinding are least effective in restoring the corrosion resistance (17) of the base metal. A combination of mechanical cleaning followed by pickling or passivation provides maximum corrosion resistance.

**Table 31** summarizes the effectiveness of several post-fabrication cleaning methods. **Figure 38** shows the relative effectiveness of several cleaning methods, based on the resulting corrosion resistance (i.e. critical pitting temperature), when applied to weld, HAZ and base metal.

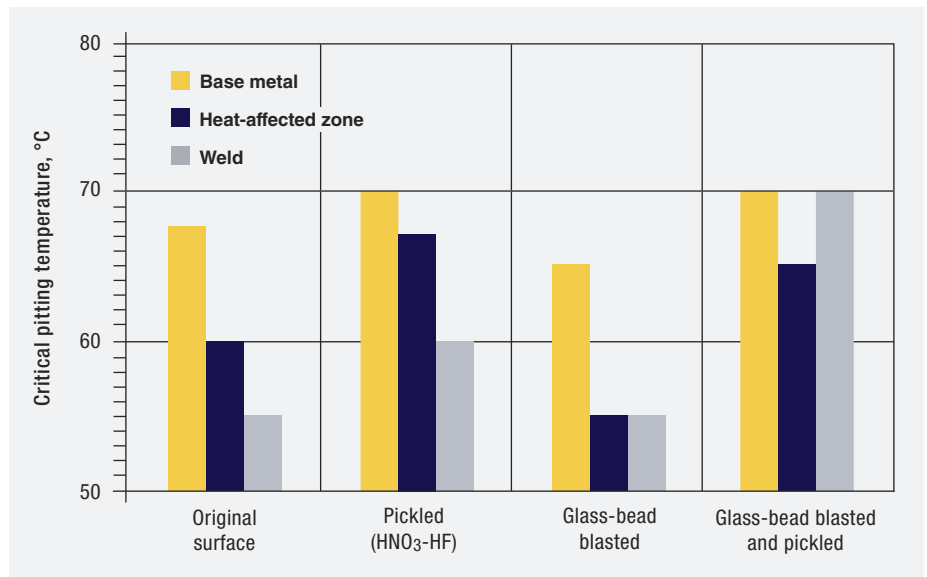

Figure 38: Effectiveness of various cleaning methods on pitting resistance of a 6% Mo stainless steel, as measured by CPT. (33)

# References

- 1 Antero Kyrolainen, Martti Vilpas, and Hannu Hanninen, *J of Materials Engineering and Performance*, Vol. 9 December 2000, p 669.
- 2 *Welding of Stainless Steels and Other Joining Methods*, American Iron and Steel Institute, Washington DC and Nickel Institute, Toronto, 1979. Available as Nickel Institute Publication No. 9002.
- 3 M. G. Fontana and N. D. Greene, *Corrosion Engineering*, 2nd Edition, McGraw-Hill, Boston, p 59, 1978.
- 4 Novak, C. J., "Structural and Constitution of Wrought Austenitic Stainless Steels", Chapter 4 of *Handbook of Stainless Steels*, Peckner, D. & Bernstein, I. M., Eds, McGraw-Hill, 1977, p 4-45.
- 5 *Guidelines for the Welded Fabrication of Nickel Stainless Steels for Corrosion Resistance Service*, Nickel Institute Toronto, rev. 2020. Available as Nickel Institute Publication No. 11007.
- 6 Weiss, B. and Stickler, R., *Metallurgical Transactions*, Vol. 3, 1972, p 851.
- 7 Unpublished data, provided by Outokumpu.
- 8 The influence of N, Mo, and Mn on the microstructure and corrosion resistance of austenitic stainless steels, R.F. A. Jargelius-Petersson, Doctoral Thesis, Dept. of Materials Science and Engineering, Royal Institute of Technology, S-100 44 Stockholm, Sweden, Loharad, 1998.
- 9 M. O. Speidel and P. J. Uggowitzer, "High Manganese, High Nitrogen Austenitic Stainless Steels: Their Strength and Toughness", in *Proceedings of Two Conferences on High Manganese Austenitic Steels: the First Conference Held in Conjunction with ASM International's Materials Week '87*, Cincinnati, Ohio, 10-15 October 1987; the Second Conference Held in Conjunction with ASM International's Materials Week '92, Chicago, Illinois, 2-4 November 1992, R. A. Lula, ed., American Society for Metals, Metals Park, 1992.
- 10 *High Performance Stainless Steels*, Nickel Institute, Toronto, 2000. Available as Nickel Institute Publication No. 11021.
- 11 *Corrosion Resistance Tables: Metals, Nonmetals, Coatings, Mortars, Plastics, Elastomers, and Linings and Fabrics*, CRC Press, 5th edition (2004), Philip A. Schweitzer (editor).
- 12 Sandvik, on-line corrosion tables.
- 13 BAM Dangerous Goods Database version 12.1.
- 14 M. G. Fontana and N. D. Greene, *Corrosion Engineering*, 2nd Edition, McGraw-Hill, Boston, p 62, 1978.
- 15 American Boat & Yacht Council, Electric Division Standard ABYC E-2 Cathodic Protection, p 9, July, 2013.
- 16 *Designer Handbook Stainless Steel Fabrication*, Specialty Steel Industry of North America.
- 17 *ASM Specialty Handbook, Stainless Steels*, Edited by J. R. Davis, ASM International 1994, p 261.
- 18 *Stainless Steel Informational Series, The Fabrication Of Stainless Steel*, Southern Africa Stainless Steel Development Association (SASSDA), 2017.
- 19 *Stainless Steel Fabrication*, Allegheny Ludlum Steel Corp, 1959.
- 20 Curtis W. Kovach, "Sulfide Inclusions and the Machinability of Steel", in *Sulfide inclusions in steel: Proceedings of an International Symposium*, 7-8 November 1974, J. J. deBarbadillo and Edwin Snape, Eds., American Society for Metals, Metals Park, 1975.
- 21 Compiled from Avesta Sheffield Machining Guidelines, now out of print and replaced by *Machining Handbook*, Outokumpu, 3rd Edition, 2019
- 22 "Heat Treating of Stainless Steels", *ASM Handbook*, Vol. 4, Heat Treating, p 774, ASM International, Materials Park, 1991.
- 23 *Welding Handbook*, Outokumpu, 2nd Edition, 2019
- 24 *Matchless in Stainless, Practice and Products for Stainless Steel Welding*, voestalpine Böhler Welding Group GmbH.
- 25 *The Avesta Welding Manual, Practice and products for stainless steel welding*, Avesta Welding AB, Avesta Sweden (2004).

- 26 Richard E. Avery, "Pay Attention to Dissimilar Metal Welds: Guidelines for Welding Dissimilar Metals", Chemical Engineering Progress, May 1991, American Institute of Chemical Engineers, Danbury. Available as Nickel Institute Publication No. 14018.
- 27 Design Manual for Structural Stainless Steel, 4th Ed., The Steel Construction Institute, 2017. Available from [www.steel-stainless.org/designmanual](http://www.steel-stainless.org/designmanual)
- 28 Working With Stainless Steels, Pierre-Jean Cunat, Brussels, Euro Inox, p 117.
- 29 Euro Inox, Adhesive Bonding of Stainless Steels, Materials and Application Series, Volume 21.
- 30 Stainless Steels in Architecture, Building and Construction – Guidelines for Corrosion Prevention, Nickel Institute, Toronto, 2001. Available as Nickel Institute Publication No. 11024.
- 31 W. L. Silence, P. Cook, J. R. Dillman, and F. G. Hodge, "The Effect of Surface Iron Contamination on the Corrosion Resistance of Alloys in Simulated FGD Environments", Paper 482, Corrosion 98, National Association of Corrosion Engineers, Houston, TX, 1998.
- 32 J. F. Grubb, "Pickling and Surface Chromium-Depletion of Corrosion Resistant Alloys", Stainless Steels '91, Proceedings of the International Conference on Stainless Steels, 1991, Chiba, p 944-951 ISIJ, 1991.
- 33 A. Tuthill and R. E. Avery, "Specifying Stainless Steel Surface Treatments", Advanced Materials and Processes, December 1992. Available as Nickel Institute Publication No. 10068.



# Suggested additional reading

## Specifications

Specifying Stainless Steel Surface Treatments, Nickel Institute Publication No. 10068

## Metallurgy

Handbook of Stainless Steels, Peckner, D. & Bernstein, I. M., McGraw-Hill, 1977

High Performance Stainless Steels, Nickel Institute Publication No. 11021, Nickel Institute, Toronto, Canada

## Corrosion

Corrosion of Stainless Steels, 2nd edition, A. John Sedriks, John Wiley & Sons, Inc., 1996

Corrosion Resistance Tables, 5th edition, Philip A Schweitzer, Marcel Dekker, Inc., 2004

Corrosion Handbook, 11th edition, Outokumpu, 2015

Experience Survey – Stress Corrosion Cracking of Austenitic Stainless Steels in Water, MTI Publication No. 27, Materials Technology Institute of the Chemical Industry

## Fabrication

Fabrication of Chromium-Nickel Stainless Steels (300 series), Nickel Institute Publication No. 428, Nickel Institute, Toronto, Canada

Fabrication and Post-Fabrication Cleanup of Stainless Steels, Nickel Institute Publication No. 10004, Nickel Institute, Toronto, Canada

Practical guide to Using 6Mo Austenitic Stainless Steel, Nickel Institute Publication No. 10032, Nickel Institute, Toronto, Canada

Fabrication Options for Nickel Containing Alloys in FGD Service: Guidelines for Users, Nickel Institute Publication No. 14029, Nickel Institute, Toronto, Canada

Handbook of stainless steel, 2nd edition, Outokumpu, 2017

Machining Handbook, 3rd edition, Outokumpu, 2019

Sheet Metal Forming Handbook, Outokumpu, 2017

Practical Guidelines for the Fabrication of Duplex Stainless Steels, 3rd edition, International Molybdenum Association Publication, London, UK, 2014

Pickling and Passivating Stainless Steel (Materials and Applications Series, Volume 4), Euro Inox, Brussels, Belgium, 2004

Stainless Steel in Contact with Other Metallic Materials, (Materials and Application Series, Volume 10), Euro Inox, Brussels, Belgium, 2009

Electropolishing Stainless Steels, (Materials and Application Series, Volume 11), Euro Inox, Brussels, Belgium, 2010

Designer Handbook Stainless Steel Fabrication, Specialty Steel Industry of North America

## Welding

EN Standard: Welding Recommendations for Welding Metallic Materials, Part 3, Arc Welding of Stainless Steel (EN 1011-3)

Welding Metallurgy and Weldability of Stainless Steels, John C. Lippold and Damain J. Kotecki, John Wiley & Sons, Inc., 2005

Stainless Steels Welding Guide, Damian Kotecki and Frank Armao, The Lincoln Electric Company, 2003.

Welding Metallurgy, 2nd edition, Sindo Kou, John Wiley & Sons, Inc., 2002

Welding Handbook, 2nd edition, Outokumpu, 2019

Stainless Steel and Nickel-base Cored Wires to Join Stainless Steel, Voestalpine Böhler Welding, 2018

Welding of Stainless Steels (Materials and Applications Series, Volume 3), Euro Inox, Brussels, Belgium, 2001

Guidelines on the Welded Fabrication of Stainless Steels (Materials and Application Series, Volume 9), Euro Inox, Brussels, Belgium, 2007

Weld Fabrication of a 6% Molybdenum Alloy to Avoid Corrosion in Bleach Plant Service, Nickel Institute Publication No. 14020, Nickel Institute, Toronto, Canada

Guidelines for Welding Dissimilar Metals, Nickel Institute Reprint Series No. 14018, Nickel Institute, Toronto, Canada.

# ASTM specifications

Flat-rolled stainless steel products	
A480/A480M*	General requirements for flat-rolled stainless and heat-resisting steel plate, sheet, and strip
A240/A240M*	Chromium and chromium-nickel stainless steel plate, sheet, and strip for pressure vessels and for general applications
A666	Annealed or cold-worked austenitic stainless steel sheet, strip, plate, and flat bar
Long-rolled or forged stainless steel products	
A484/A484M*	General requirements for stainless steel bars, billets, and forgings
A555/A555M	General requirements for stainless steel wire and wire rods
A276/A276M	Stainless steel bars and shapes
A479/A479M*	Stainless steel bars and shapes for use in boilers and other pressure vessels
A564/A564M	Hot-rolled and cold-finished age-hardening stainless steel bars and shapes
A314	Stainless steel billets and bars for forging
A473	Stainless steel forgings
A313/A313M	Stainless steel spring wire
A368	Stainless steel wire strand
A492	Stainless steel rope wire
A580/A580M	Stainless steel wire
Tubular stainless steel products	
A999/A999M*	General requirements for alloy and stainless steel pipe
A1016/A1016M*	General requirements for ferritic alloy steel, austenitic alloy steel, and stainless steel tubes
A312/A312M*	Seamless and welded austenitic stainless steel pipe
A358/A358M*	Electric-fusion-welded austenitic chromium-nickel stainless steel pipe for high-temperature service
A409/A409M	Welded large diameter austenitic steel pipe for corrosive or high-temperature service
A778/A778M	Welded, unannealed austenitic stainless steel tubular products
A813/A813M	Single- or double-welded austenitic stainless steel pipe
A814/A814M	Cold-worked welded austenitic stainless steel pipe
A249/A249M*	Welded austenitic steel boiler, superheater, heat-exchanger, and condenser tubes
A269/A269M	Seamless and welded austenitic stainless steel for general service
A270/A270M	Seamless and welded austenitic stainless steel sanitary tubing
A688/A688M	Welded austenitic stainless steel feedwater heater tubes

<b>Fittings, bolting, and forgings</b>	
A960/A960M	Common requirements for wrought steel pipe fittings
A962/A962M	Common requirements for steel bolting intended for use at any temperature from cryogenic to the creep range
A182/A182M	Forged or rolled alloy-steel pipe flanges, forged fittings, and valves and parts for high-temperature service
A193/A193M	Alloy-steel and stainless steel bolting materials for high-temperature service
A194/A194M	Carbon, and alloy steel nuts for bolts for high pressure and high-temperature service
A403/A403M	Wrought austenitic stainless steel pipe fittings

Note: For each category of stainless steel products, the general requirements specification is shown first in the Table, followed by specifications for particular products. The general requirements are referenced by each of the individual product specifications so it is not necessary to specify anything other than the product specification. For example ordering A240 sheet will automatically apply all requirements of A480.

\* A specification having a corresponding "SA-" specification of the same number in section II of the ASME Boiler and Pressure Vessel Code.

# EN specifications

EN ISO 3581:2016	Welding consumables. Covered electrodes for manual metal arc welding of stainless and heat-resisting steels – Classification
EN 10028-7:2016	Flat products made of steels for pressure purposes – Part 7: Stainless steels
EN 10088-1:2014	Stainless steels – Part 1: List of stainless steels
EN 10088-2:2014	Stainless steels – Part 2: Technical delivery conditions for sheet/plate and strip of corrosion resisting steels for general purposes
EN 10088-3:2014	Stainless steels – Part 3: Technical delivery conditions for semi-finished products, bars, rods, wire, sections and bright products of corrosion resisting steels for general purposes
EN 10151:2002	Stainless steel strip for springs – Technical delivery conditions
EN 10213:2007+A1:2016	Steel castings for pressure purposes
EN 10222-5:2017	Steel forgings for pressure purposes – Part 5: Martensitic, austenitic and austenitic-ferritic stainless steels
EN 10250-4:1999	Open steel die forgings for general engineering purposes – Part 4: Stainless steels
EN ISO 9445-1:2010	Cold-rolled stainless steel narrow strip and cut lengths – Part 1: Tolerances on dimensions and shape
EN ISO 9445-2:2010	Cold-rolled stainless and heat resisting steel wide strip and plate/sheet – Part 2: Tolerances on dimensions and shape
EN 10269:2013	Steels and nickel alloys for fasteners with specified elevated and/or low temperature properties
EN 10270-3:2011	Steel wire for mechanical springs – Part 3: Stainless spring steel wire
EN 10272:2016	Stainless steel bars for pressure purposes
EN 10283:2010	Corrosion resistant steel castings
EN 10312:2002/A1:2005	Welded stainless steel tubes for the conveyance of water and other aqueous liquids – Technical delivery conditions
EN ISO 14343:2009	Welding consumables – Wire electrodes, strip electrodes, wires and rods for arc welding of stainless and heatresisting steels – Classification
EN 10216-5:2013	Seamless steel tubes for pressure purposes – Technical delivery conditions – Part 5: Stainless steel tubes
EN 10217-7:2014	Welded steel tubes for pressure purposes – Technical delivery conditions – Part 7: Stainless steel tubes

# Registered trademarks and trade names

UNS No. (Grade)	Common producer registered trademarks and trade names	Company
N08020	20Cb-3 <sup>®</sup>	Carpenter Technology Corporation
N08904 (904L)	ATI 904L <sup>™</sup> UR <sup>™</sup> 904L Ultra <sup>®</sup> 904L	ATI Properties, Inc. Industeel - ArcelorMittal Outokumpu
N08028	Sanicro <sup>®</sup> 28 INCOLOY <sup>®</sup> Alloy 28 UR <sup>™</sup> 28	Sandvik AB Special Metals Corporation Industeel - ArcelorMittal
S34565	ATI 4565 <sup>™</sup> UR <sup>™</sup> 4565	ATI Properties, Inc. Industeel - ArcelorMittal
N08026	20Mo-6 <sup>®</sup> INCOLOY <sup>®</sup> alloy 25-6MO	Carpenter Technology Corporation Special Metals Corporation
S32053	NAS 254N	Nippon Yakin Kogyo Co.
N08926	VDM <sup>®</sup> Alloy 926, Cronifer <sup>®</sup> 1925 hMo NAS 255NM UR <sup>™</sup> 926 Ultra <sup>®</sup> 6XN	VDM Metals International GmbH Nippon Yakin Kogyo Co. Industeel - ArcelorMittal Outokumpu
S31254	254 SMO <sup>®</sup> UR <sup>™</sup> 254	Outokumpu Industeel - ArcelorMittal
N08367	AL-6XN <sup>®</sup> UR <sup>™</sup> 367 Ultra <sup>®</sup> 6XN	ATI Properties, Inc. Industeel - ArcelorMittal Outokumpu
S31266	UR <sup>™</sup> 66	Industeel - ArcelorMittal
S31277	INCOLOY <sup>®</sup> alloy 27-7MO	Special Metals Corporation
N08031	VDM <sup>®</sup> Alloy 31, Nicrofer <sup>®</sup> 3127 ATI 31 <sup>™</sup> UR <sup>™</sup> 31	VDM Metals International GmbH ATI Properties, Inc. Industeel - ArcelorMittal
N08354	NAS 354N	Nippon Yakin Kogyo Co.
N08935	Sanicro <sup>®</sup> 35	Sandvik AB
S32654	654 SMO <sup>®</sup>	Outokumpu

Co-published with:

INTERNATIONAL  
CHROMIUM  
DEVELOPMENT  
ASSOCIATION 

ISBN 978-1-907470-13-4